

# AFS program and the Hot Gas Filter Decision Guide

- *This sequence of power points will be displayed at 10AM April 29 and will be the background for the discussion*
- AFS Program Overview
- Decision Guide, Decision Orchard, AFS, and International Filter News
- Hot Gas Filtration Decision Guide

# AFS Program Overview

## General

- The 90 minute session will be focused on a slide by slide display of the summary power points.
- As each slide is displayed there is the opportunity for discussion. It would start with the slide author if he so wishes
- Designated panelists as well as the entire group will be encouraged to ask questions and make observations
- Panelists and participants are encouraged to submit power points to be included in the summary
- Anyone is encouraged to submit articles and presentations for inclusion in the Power Plant Decision Orchard
- The Filtration News article in June will be based on the conclusions reached in the session
- The summary and the intelligence system will be continually updated

## “Specific

- Provide access to hot gas filter Decision Guide upon registration
- Provide updated version of HGF Decision Guide prior to the event
- Provide contact among presenters and attendees before , during and after the event.
- Conduct the program as a series of panels
- Presenters sit at designated tables during lunch and continue discussions
- Continuing upgrading of Hot Gas Filter Decision Orchard and articles in IFN

# Hot Gas Filter Summary is part of a whole system

			IFN article			
		-- Hot Gas Filter Decision Guide -				
	-----Power Plant Decision Orchard-----					
	<p>4As Operating system</p> <ul style="list-style-type: none"> <li>• <b>Alerts:</b> Weekly Power Alert, fabric filter newsletter</li> <li>• <b>Answers:</b> Orchard Answers with Decision guide locator</li> <li>• <b>Analysis:</b> conference debates, hot topic hours , expert support , white papers and <a href="#">InterWebviews™</a> in many languages</li> <li>• <b>Advancement:</b> recorded webinars and access to program</li> </ul>					
	-----Global Decisions Orchard-----					

The Decision Guide is part of a whole system. It is route map to the larger database display ( Power Plant Air Quality Decisions ) This in turn is part of a complete service for coal fired power plant operators- *Power Plant Systems and Components*. The June Filtration news article will be a compressed version of the revised summary as shaped by the AFS session.

# Decision Guide to select hot gas filters and media

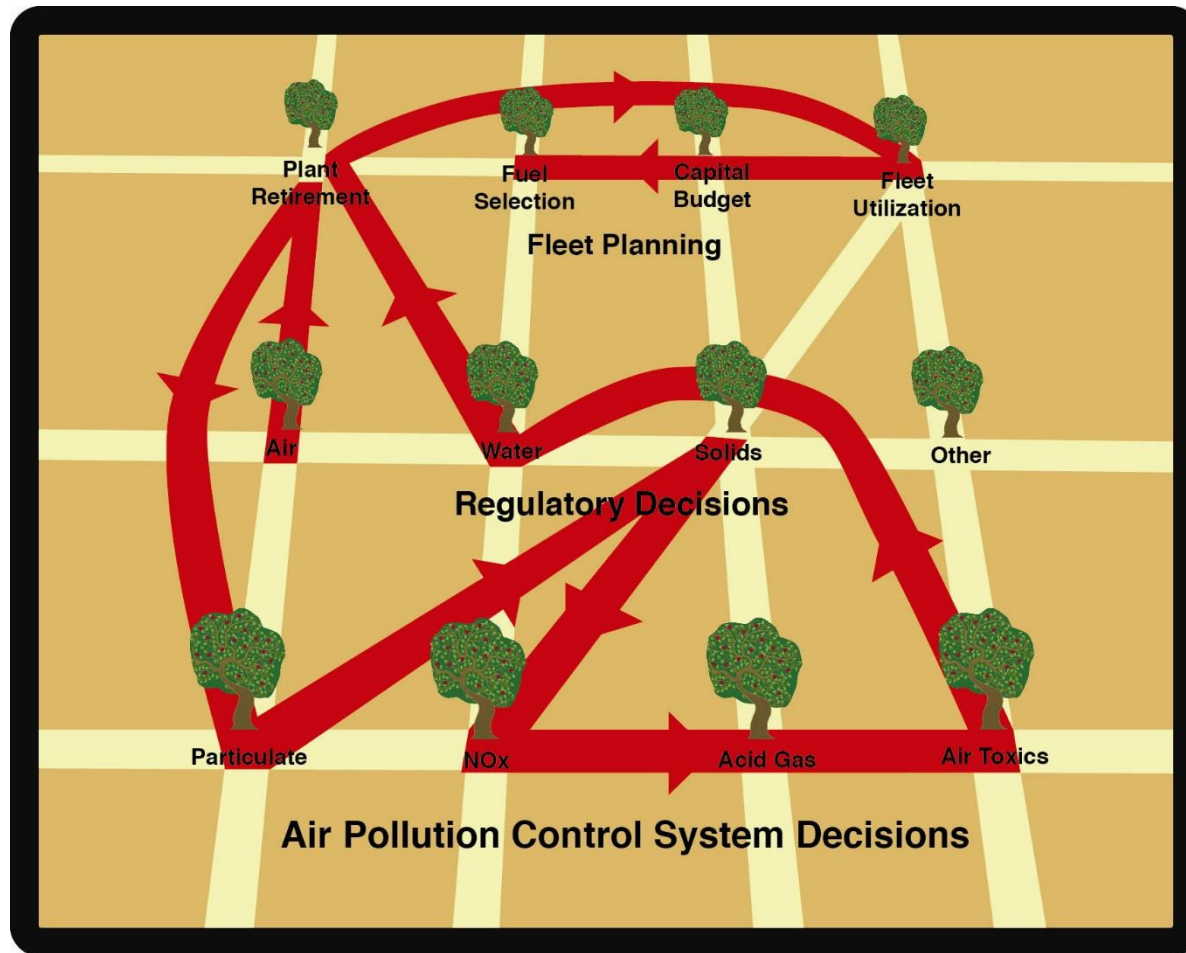

# Panelists

Company	Name
AEP	Tom Hart
Babcock & Wilcox	Steve Feeney
Consultant	Rich Miller
Donaldson	Eddie Ricketts
Durr	Martin Shroter
ETS	John McKenna
F.L. Smidth	John Johnson
Filtration Group	John Eleftherakis
Haldor Topsoe	Nate White
Purolator	Pavlos Papadopoulos
SEI	Mick Chambers or Hardik Shah
Testori	Clint Scoble

# Hot Gas Filtration Decision Guide

A route map and summary of options available and merits of each based on purchasers unique circumstances

*Modified for AFS April 29 Discussion*

**Hot Gas Filtration<sup>®</sup>**  
*Decision Guide*  
*(Orchard route map)*

Click on Cells for Information

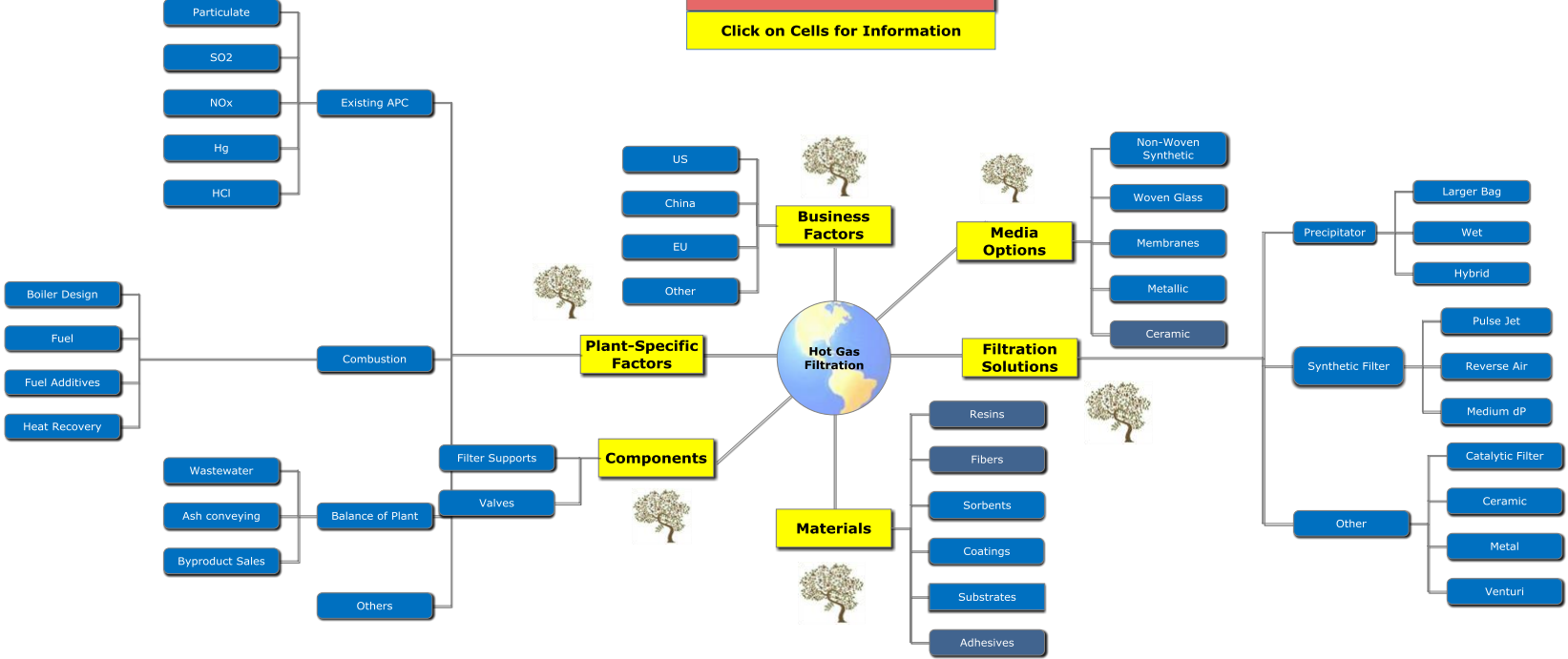

# Business Factors

## Regulatory

- U.S
- EU
- China
- Other

## Economic

- Macro
  - Plant life
  - Parasitic power cost
- Micro

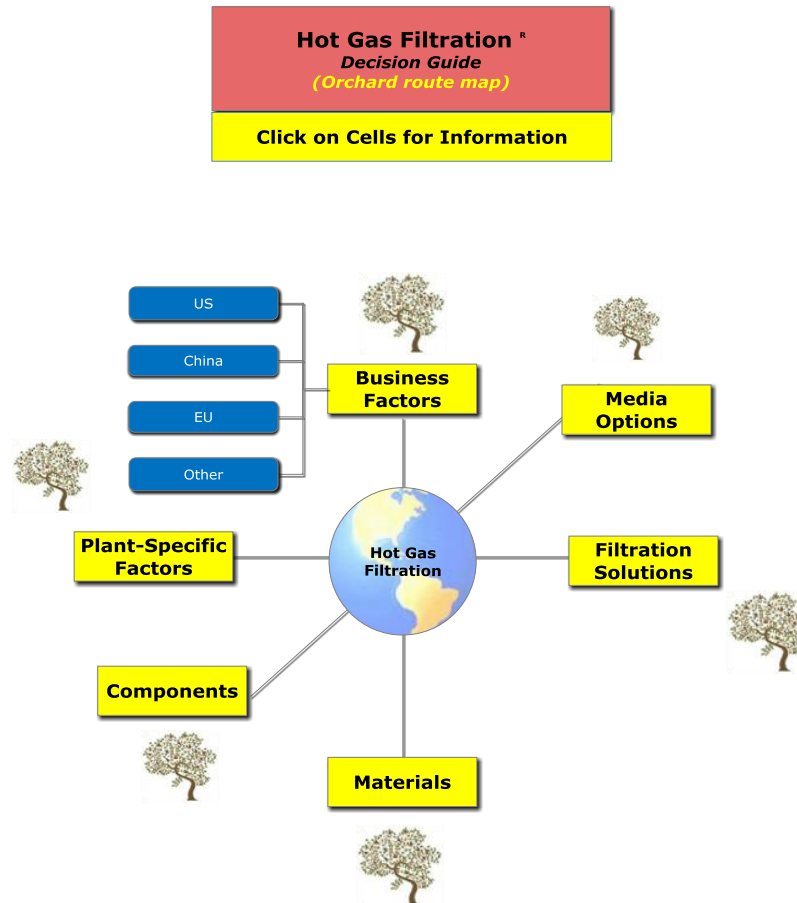



# Regulatory, Economic and plant specific impacts on filter choice

Subject	Author	Relevant decision
Regulations and Technology	Mcilvaine	<b>Many Different Options created</b>
Emission limits-World	Mcilvaine	<b>New approaches needed to meet new regulations</b>
China limits	Mcilvaine	<b>Will new rules here influence rules for you?</b>
U.S. regulations	Hot topic	<b>Multiple pollution control requires multiple decisions</b>
Cement and other	Mcilvaine	<b>Other industries have the same multiple decisions</b>
PM 2.5 ambient	Troutman-Sanders	<b>Need to evaluate future requirements due to ambient State limits</b>
Condensibles	Hamon	<b>Need to consider small sulfuric acid particle diameter</b>
Method 5 catch	Hamon	<b>Standard method shows large condensable fraction and may not be valid</b>

# Regulations and technology are changing the hot gas filter choices

- China and the U.S. are leading the way with tough particulate emission requirements for power plants.
- Ambient regulations in U.S. states and counties as well as stack regulations for certain cities and provinces in China are much tougher than the national requirements
- The definition of particulate involves size fractions e.g 2.5 microns and physical state ( discrete or condensable)
- Requirements involve new and existing installations each with a different set of site specific conditions
- The need to reduce mercury, other toxic metals, HCl, and SO<sub>2</sub> changes the particulate reduction decisions.
- Upgrading dry precipitators with new electricals is one option
- One very active retrofit option is replacing the internals of precipitators with fabric bags.
- Wet precipitators are being used in some of the newer U.S. and Chinese installations
- Various dry scrubber/ fabric filter combinations are popular
- The ceramic catalytic filter offers potential of small foot print and with DSI can also capture acid gases.
- Metal filters offer an alternative separation at temperatures of 850F and extraction of heat from the clean gas.
- **Many different options based on new regulations and new filter designs**

# Emission limits for coal plants around the world in mg/Nm<sup>3</sup>

pollutant	China Guangzhou, Shanxi	Sinopec Guangzhou	Zhejiang with SCR and WESP	China national regional I	U.S Existing/new	EU Existing/new
NOx	50	1.4 to 28.5	23,7	200/100	1060-640/117	200/200
SO <sub>2</sub>	35	2.85 to 7.6	15	200-400/100	350/65	400/200
PM	5	3.4 to 4.6	3.08	30	45/8	50
SO <sub>3</sub>	5	0.08				
Hg	0.003	0.0004 ug		.03	0.002/0.001	

**New approaches needed to meet tough new regulations**

# China now has the most stringent particulate limits

- Due to pressure from citizens due to smog, the Chinese government is initiating the toughest air regulations of any country
- Tough national standards have now been followed by even more stringent standards in a number of cities and even provinces
- the new national standard of 30 mg/Nm<sup>3</sup> for particulate was already tougher than the regulation for existing U.S. coal plants or for plants in the EU.
- The new regulation in Guangzhou and Shanxi limits dust to only 5 mg.
- Existing precipitators will not be able to meet these limits. Zhejiang is meeting the new requirements with a wet precipitator.
- Sinpoec Guangzhou is meeting the standards with a dry scrubber fabric filter system complete with activated carbon injection installed by Longking
- **Will Chinese rules influence rules elsewhere**

# U.S regulations will dictate new hot gas filter approaches



## MATS and CSAPR

---

### **Mercury and Air Toxics Standards (MATS)**

- Limits emissions of toxic air pollutants from coal and oil fired power plants
- Primary pollutants of concern are mercury, hydrogen chloride (HCl) and fine particulates (PM<sub>2.5</sub>)
- FINAL RULE: Compliance by April 2015 with possible extensions of up to 2 years

### **Cross State Air Pollution Rule (CSAPR)**

- Referred to as the “Good Neighbor” rule
- Regulates emissions from one state that may have a negative impact on air quality in a downwind state
- 28 states in the eastern half of the U.S. must limit state-wide emissions of precursors to ozone formation (NO<sub>x</sub>, SO<sub>2</sub> and PM<sub>2.5</sub>)
- FINAL RULE issued August 2011 with first phase to begin in 2012
  - But, the rule did not take effect as scheduled due to litigation
  - August 2012: US Court of Appeals vacated the rule and remanded it to EPA
  - April 2014: US Supreme Court reversed Court of Appeals and reinstated CSAPR
  - November 2014: EPA issued new compliance dates of 2015 to 2017

### **Together, MATS and CSAPR will require coal plants to install:**

- FGD or Dry Sorbent Injection (DSI) to control SO<sub>2</sub> and acid gases (HCl)
- SCR or SNCR to control NO<sub>x</sub>
- Fabric filters or electrostatic precipitators to control particulate matter
- Activated carbon injection units to reduce mercury

7

**Control of multiple pollutants requires multiple decisions**

# Cement, power and other industries have tight emission standards

- Waste to energy plants have been subjected to tight particulate limits for some time
- Cement plants are finding that precipitators are inadequate to meet regulations in most countries
- The new MACT regulations in the U.S. provide tough requirements for industrial boilers and cement plants
- The MATS regulations in the U.S. provide particulate challenges related to using particulate as a surrogate for toxic metals
- Mining operations, pulp mills and other industries are also facing the necessity of improving particulate capture
- Particulate removal GDPS™ has to take into account the requirements for reduction of other pollutants

# MATS PROGRAM STATUS

- Regulates Mercury, Metals HAPS, Acid Gases and Dioxin/Furans
- Mercury
  - <1.2 lbs Hg/Tbtu (except Pirkey 4.0# Hg/TBbtu)
  - Monitored for reporting with Sorbent Traps on Fleet
  - Most plants will use mercury CEMS of operational indication
- Acid Gases
  - <0.002 lbs HCl/Mbtu
  - Reporting across fleet:
    - SO<sub>2</sub> as a surrogate (<0.2#SO<sub>2</sub>/MBtu)
    - or-
    - **Quarterly** stack testing for HCl
- Non-Mercury Metal HAPS
  - **Quarterly** stack particulate monitoring (<0.03 lbs particulate/Mbtu)
- Dioxin/Furans
  - Boiler inspections, repairs and tuning (CO, NO<sub>x</sub> , O<sub>2</sub>)
  - Annual reporting required.

*Supplied by Tom Hart of AEP in the hot gas discussion April 29*

# Mercury Compliance Measures

MERCURY	ACID GASES	Non-Hg Metals
SCR & WFGD	WFGD	ESP – WFGD
ACI* & Fabric Filter	SBC** & Fabric Filter DFGS & FF	Fabric Filter
ACI & NID	NID	NID
ACI & ESP	SBC & ESP	ESP
ACI & CaBr <sub>2</sub> & ESP	WFGD	ESP - WFGD
WFGD & GMCS	WFGD	ESP - WFGD

*Supplied by Tom Hart of AEP during the AFS hot gas filter session on April 29*



# BUT TODAY .....

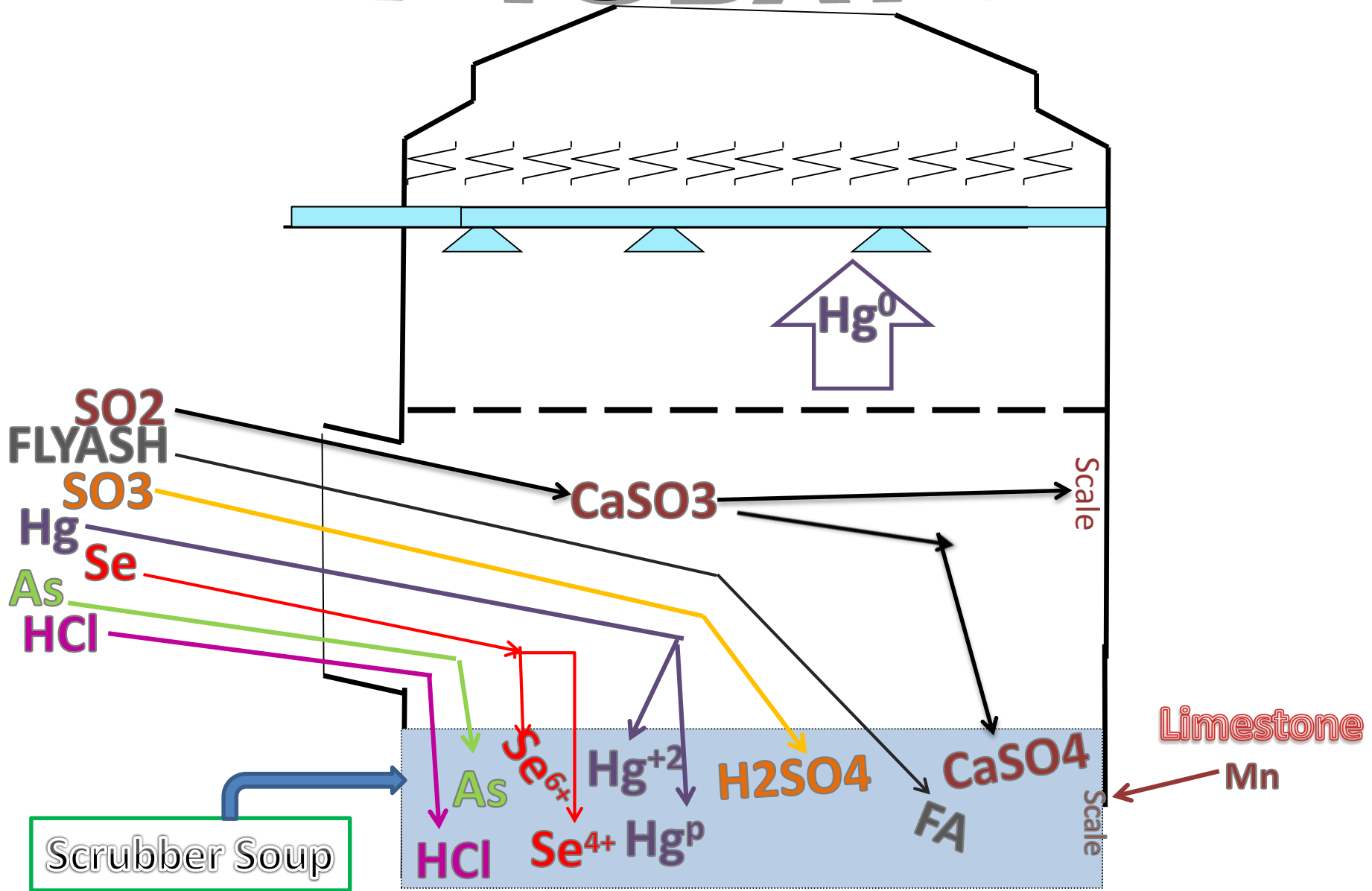

# Nothing Disappears

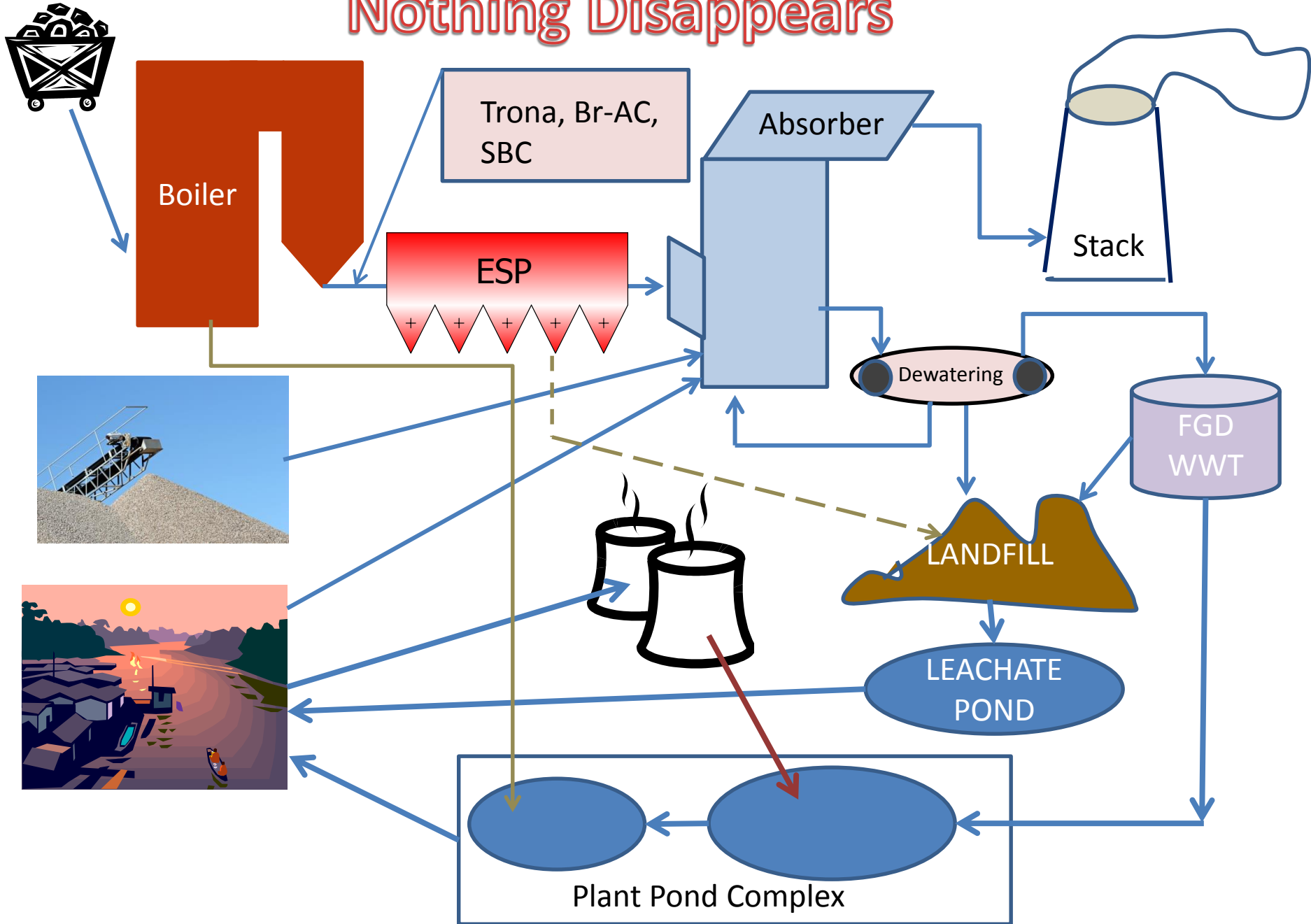

# PM 2.5 ambient standards will require reduction

TROUTMAN  
SANDERS  
ATTORNEYS AT LAW

## Fine Particulate Matter (PM<sub>2.5</sub>)

- Lowered annual standard to 12 ug/m<sup>3</sup> in December 2012
- EPA expects all areas to attain without new control requirements (except CA)
- Vacatur of de minimis levels (SILs and SMCs) could make permitting difficult
  - w/o SMCs, could require onsite monitoring
  - w/o SILs, could make modeling more difficult
- EPA's implementation rule also vacated
- EPA resets the baseline date; NC objects



Sulfuric acid mist is only 0.3  $\mu\text{m}$  in dia.

## Particle Sizes

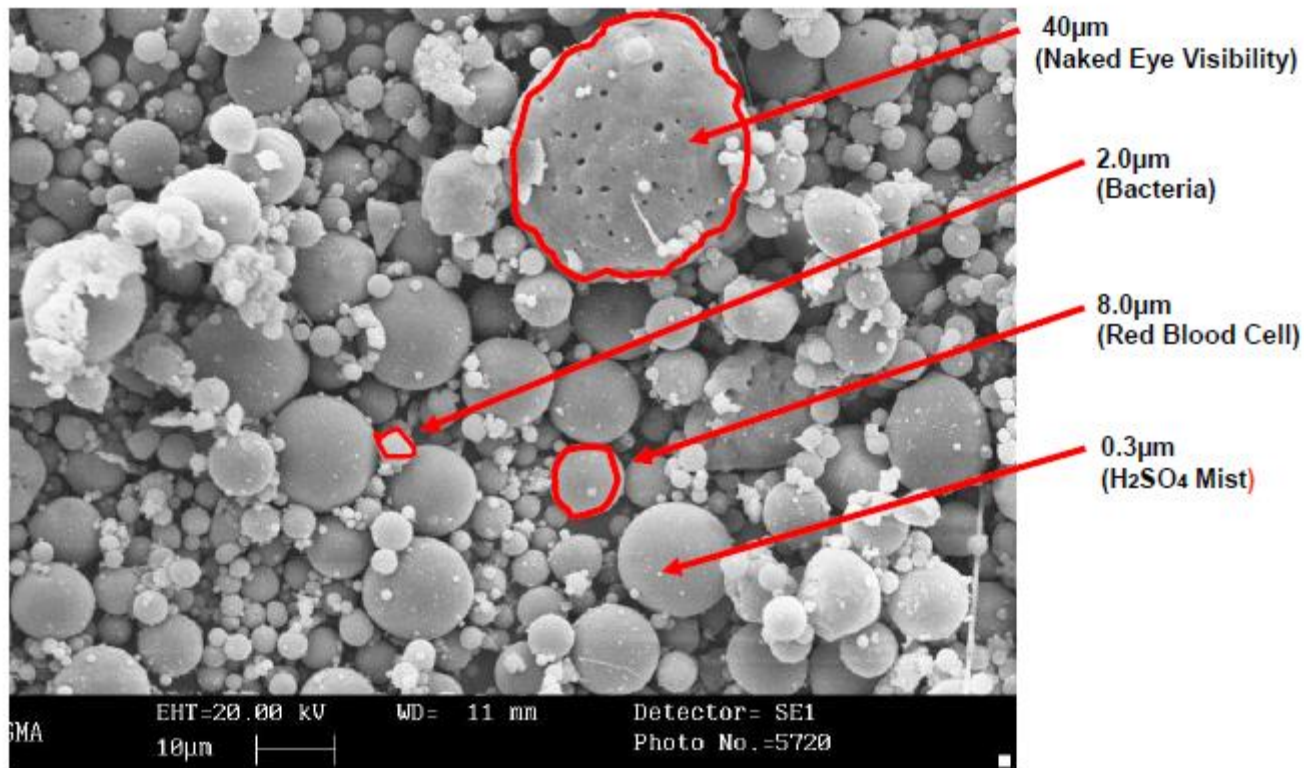

Supplied by Hamon

Choose collector to remove  
very small particles

# PM includes both discrete and condensable aerosols

## *What is PM<sub>2.5</sub> ?*

### Filterable Particulate

- <2.5 microns in size
- Exists as solid particulate at temperatures of 250°F or higher
- Collected in “front half” filter of PM test apparatus

### Condensable Particulate

- <2.5 microns in size
- Vapors that condense
- Primarily SO<sub>3</sub> (H<sub>2</sub>SO<sub>4</sub>) sulfuric acid
- Toxic metals
- Collected in “back half” impingers in PM test apparatus

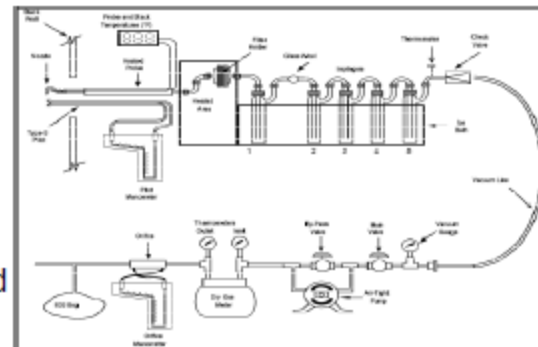

50%- 75% of PM<sub>2.5</sub> is Condensable PM

*Supplied by Hamon*

Choice may have to include condensibles

Condensibles captured in back half of Method 5 train ( Hamon)

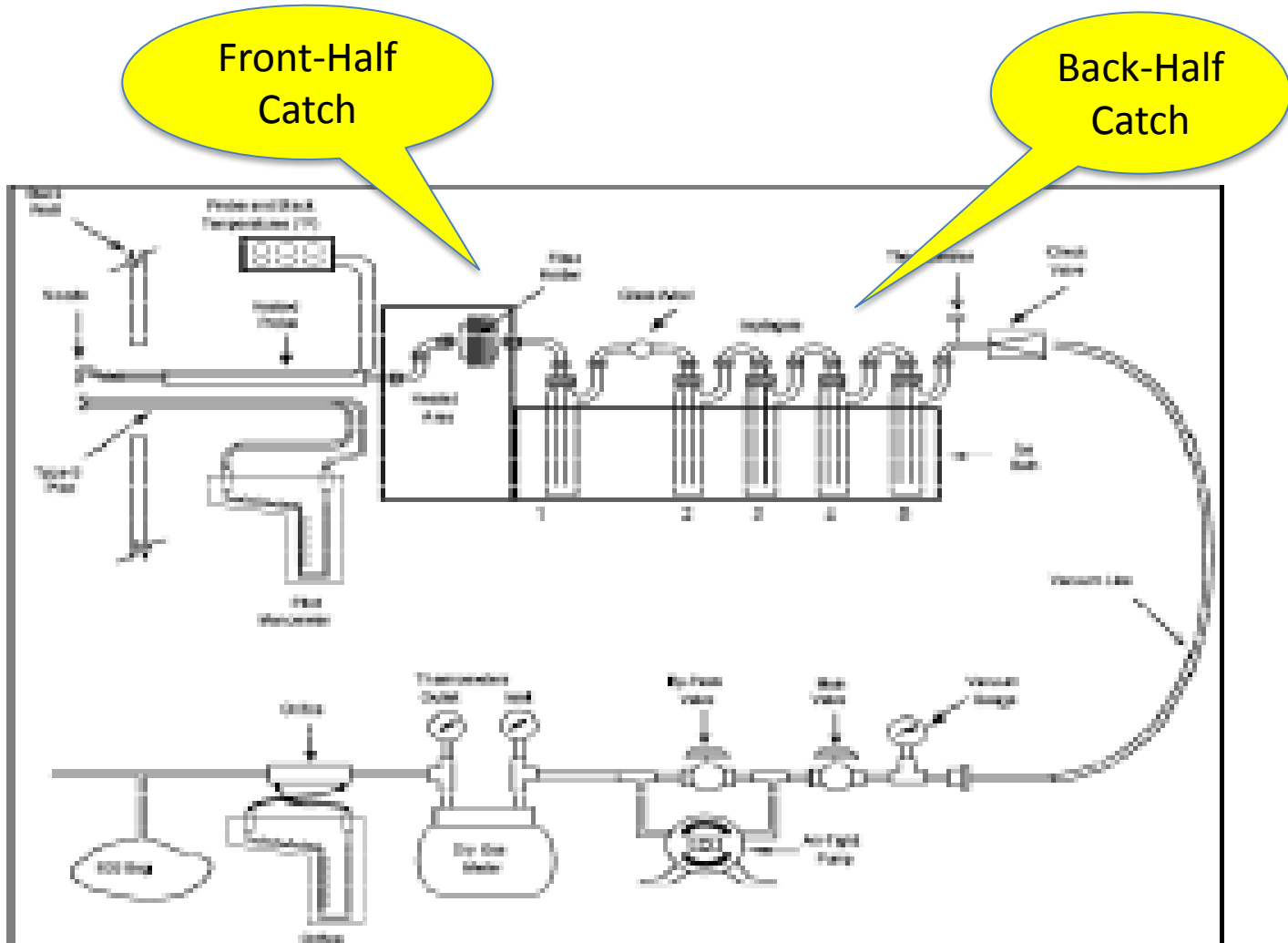

## EPA Method 8 Sampling

**Will you have to deal with this uncertain measurement ?**

# Decision Route – Reasons to address hot gas alternatives

## Recorded Sessions

HOT TOPIC WEBINARS	
January 29, 2015	<a href="#">MATS Compliance Choices</a> 91 minutes <a href="#">MORE</a>
INTERWEBVIEWS™ ( FREE )	
August 2014	<a href="#">Mercury in Mandarin</a> <i>(available in Mandarin and English by Bobby Chen of CBI)</i>
Chinese youtube version	<a href="http://youtu.be/ldq33k5UWTs">http://youtu.be/ldq33k5UWTs</a>
中国能以低成本除汞得益于美国的技术发展	
Tekran , Karl Wilber <a href="#">MACT QUESTIONS</a> <a href="#">Click Here For Complete YouTube Text</a>	
Sick, Dan Keitzer <a href="#">MACT CEMS</a> <a href="#">Click Here For Complete YouTube Text</a>	

## Decision Orchard key words

Free to end users but subscription for others)

Generic	Corporation
<a href="#">Mercury</a> 水银(汞)	, <a href="#">CB&amp;I</a> , <a href="#">Chemtura</a>
<a href="#">CEMS</a>	<a href="#">Thermo Fisher Scientific</a> , <a href="#">SICK Process Automation</a> <a href="#">Tekran Instruments</a>
Other key words <a href="#">CSAPR</a> . <a href="#">Industrial Boiler</a> <a href="#">MACT</a> <a href="#">Legislation</a> <a href="#">MATS</a> <a href="#">NAAQS</a>	

# System and APC impacts on filter choice

Subject	Author	Relevant decision
System Impacts	Mcilvaine	<b>Many process and site specific impacts have to be considered</b>
Boiler efficiency- APH	Paragon	<b>The air heater outlet temperature is variable and impacts the filter selection</b>
Mercury Considerations	CBI	<b>The filter decision must be viewed along with the many options to reduce mercury and prevent –re-emissions</b>



# Plant specific factors

## Existing APC

- Particulate
- SO<sub>2</sub>
- SO<sub>3</sub>
- Nox
- Mercury
- HCl

## Combustion

- Boiler design
- Fuel additives
- Fuel
- Heat recovery

## Balance of plant

- Wastewater
- Ash conveying
- Space available
- By product sales

# System impacts

- Heat extraction decisions must be made simultaneously with particulate control because of the inter-relationships
- The precipitator efficiency increases as the inlet temperature is reduced.
- The ability to use lower cost bags is enhanced by reducing both the gas temperature and the acid dew point
- Reduction of precipitator or baghouse inlet temperature to the acid dew point will cause corrosion and plugging problems
- Clean hot gas offers a big potential for energy recovery
- Existing rotary air heaters have inlet air leakage of 10% making the dust collectors larger than need be
- The SCR increases SO<sub>3</sub> which will lead to more condensable particulate
- Activated carbon for mercury control increases particulate emissions
- Halogen addition to the coal causes potential corrosion problems
- Dry scrubbers increase the particulate load and potential emissions and wear on bags
- Wet scrubbers downstream of a precipitator can improve total particulate capture

Boiler efficiency is a function of heat transfer in the air heater but limited by the acid dew point

## Function of an Air Heater



- Extracts Waste Heat From Exhaust Gases
- Recycles That Heat to the Incoming Air

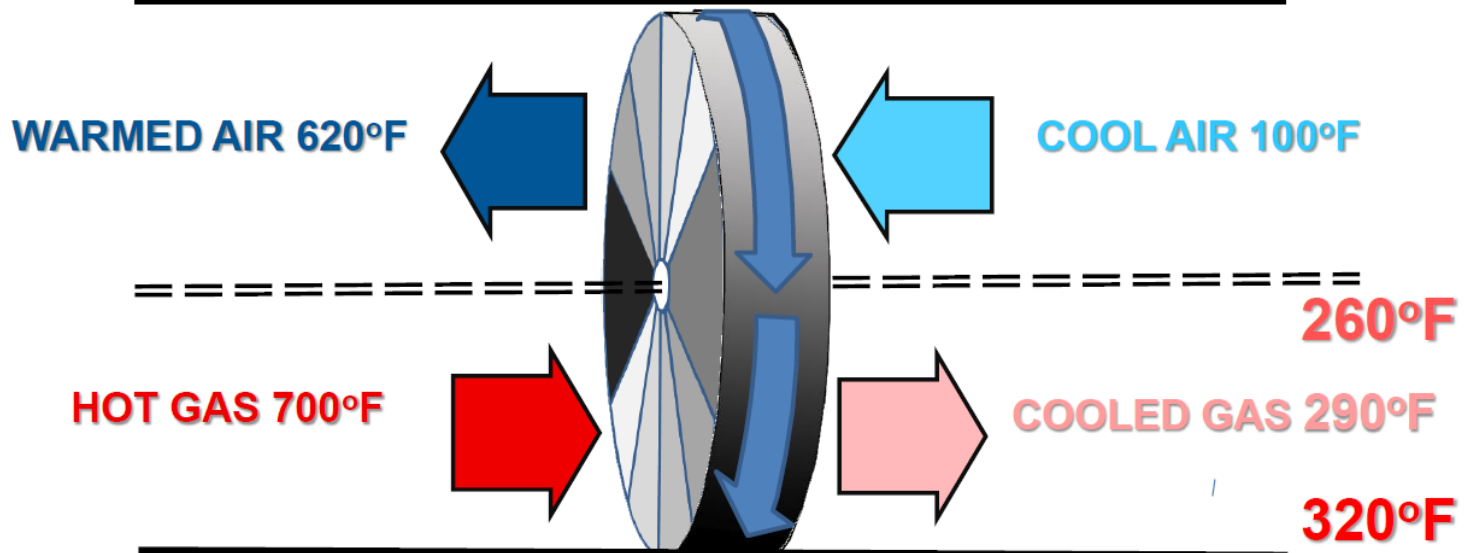

# Mercury considerations in many locations



## FGD Mercury Reemission

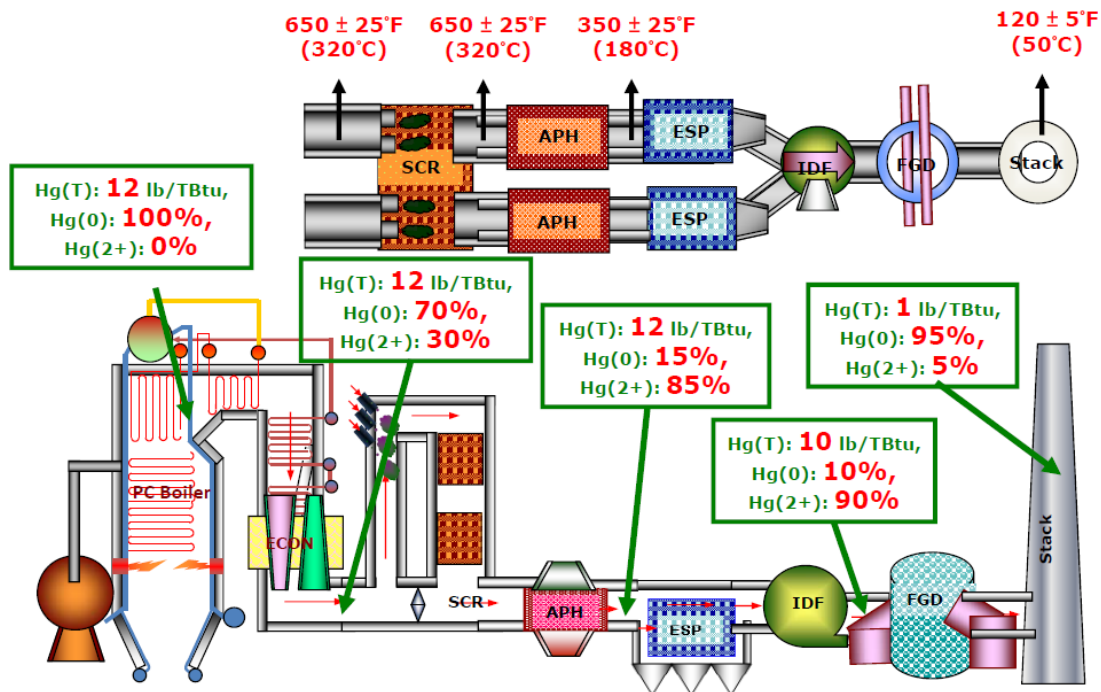

- ▶ If more than **1.0** lb/TBtu of stack Hg emission is observed, there is Hg reemission across the FGD

Mercury Re-emission Re-examined - a Thermodynamic Model to Follow, by Steve Feeney, Babcock & Wilcox  
Power Generation Group - Hot Topic Hour February 26, 2015  
Feeney, Steve

babcock & wilcox power generation group

**ACHIEVING Hg MATS SUCCESS**  
**B&W's ABSORPTION PLUS™**

- Step 1:**  
Provide sufficient up-front Hg oxidation.
- Step 2:**  
Add sulfide to precipitate the Hg from the aqueous phase.

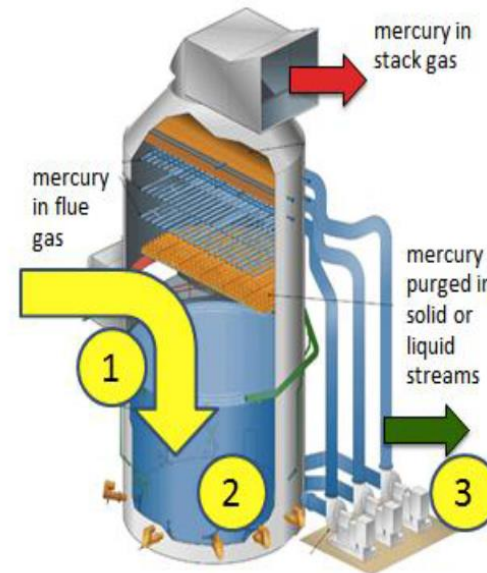

# Decision Route – System impacts

## Recorded sessions

Hot Topic Webinars	
January 29, 2015	<a href="#">MATS Compliance Choices</a> 91 minutes <a href="#">MORE</a>
<b>INTERWEBVIEWS™ ( FREE )</b>	
August 2014	<a href="#">Mercury in Mandarin</a> <i>(available in Mandarin and English by Bobby Chen of CBI)</i>
Chinese youtube version	<a href="http://youtu.be/ldq33k5UWTs">http://youtu.be/ldq33k5UWTs</a>
中国能以低成本除汞得益于美国的技术发展	
Nuendorfer, Storm, UDC analysis of back end upgrades to meet MACT view it <a href="#">on YouTube</a> ,	

## Decision Orchard key words

GENERIC	CORPORATION
<a href="#">Air Preheater</a>	<a href="#">Paragon Airheater Technologies</a>
<a href="#">Mercury</a> 水银(汞)	<a href="#">, CB&amp;I, Chemtura</a>
Other key words: <a href="#">Heat Exchange</a> <a href="#">MACT</a> <a href="#">MATS</a> <a href="#">PM2.5</a> <a href="#">SO3</a> <a href="#">Activated Carbon</a> 活性炭	

# Filter Solutions

## Precipitator

- Larger dry
- Wet
- Hybrid

## Synthetic filter

- Collector
  - Pulse jet
  - Reverse air
  - Medium dP
- Bags
  - Tubular
  - Pleated

## Other

- Catalytic
- Ceramic
- Metal
- Venturi

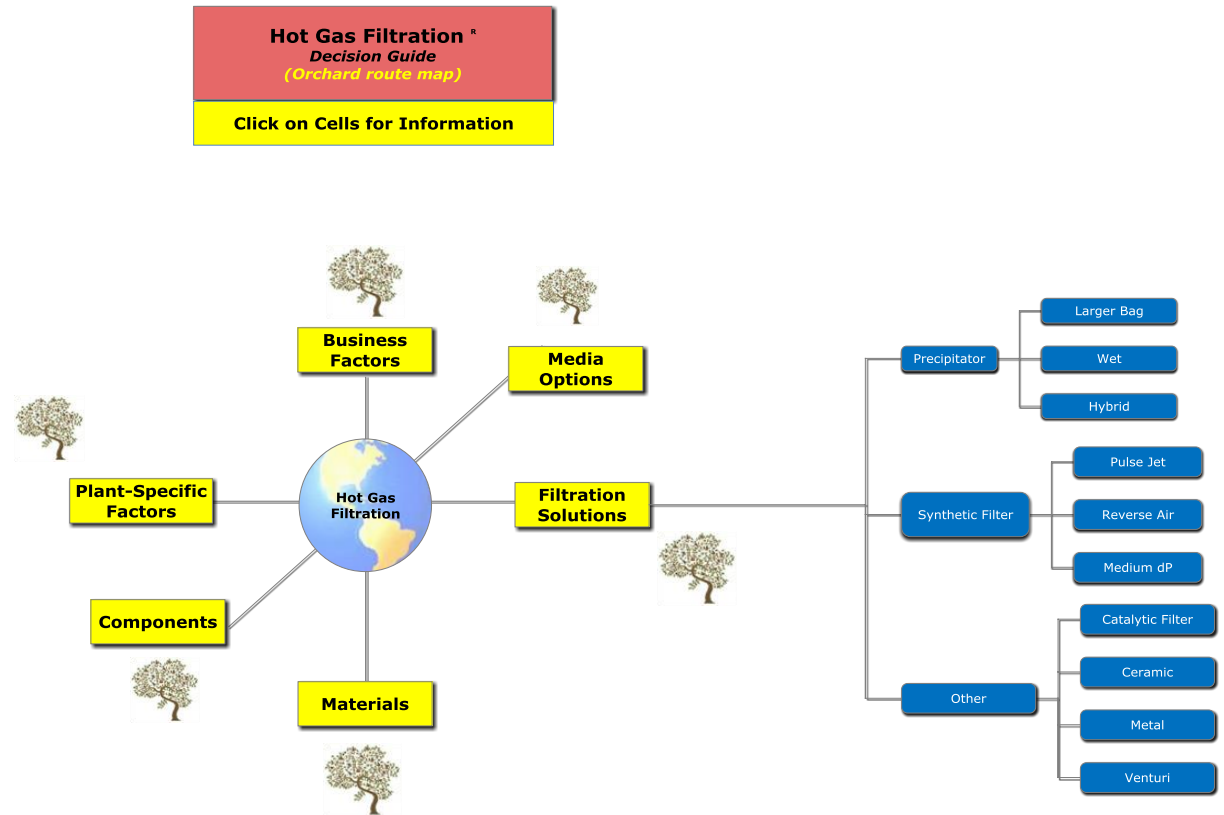

# Precipitator –Scrubber Options -1

Subject	Author	Relevant decision
All options	Mcilvaine	
Upgrade precipitator	KC Cottrell	
Component upgrade	KC Cottrell	
Recent SEI designs	SEI	
Wet precipitators	Mcilvaine	
Wet ESPs	Hamon	
WESP and SO3	Mcilvaine	
Recent installations	Hamon	



## Precipitator –Scrubber Options -2

Subject	Author	Relevant decision
Scrubber PM capture	Mcilvaine	
Dry scrubber, baghouse	longking	
Dry sorbent injection	Lhoist	
Reagents create PM 2.5		
TBD		
TBD		
TBD		
TBD		
TBD		

# Options to meet tough particulate emission limits

- Upgrade existing precipitator with new more efficient electricals
- Buy a larger precipitator- may have to double size
- Use sorbent injection prior to the air heater to reduce the acid dew point and then make the air heater bigger to reduce the precipitator inlet temperature and improve efficiency
- Install a wet precipitator after the existing precipitator and scrubber
- Replace the precipitator with a fabric filter
- Add precipitator after the fabric filter
- Replace the precipitator with a hybrid fabric filter/ESP
- Combine particulate and scrubbing in one system with a dry scrubber and fabric filter
- Install a catalytic filter or hot gas filter to meet 850 F.

# Upgrade ESP to meet MATS

## ESPs for MATS Compliance

KC Cottrell Inc. 

- Many existing power stations use ESPs for particulate collection.
- A properly designed ESP can achieve the required MATS limit for PM.
- Existing ESPs designed for previous limits may not need to be replaced.
- A variety of upgrade options can be employed, many in parallel, to improve performance.
- There is no single solution.

# Specific upgrade options-KC Cottrell

## ESP Upgrade Options

KC Cottrell Inc. 

- Improve gas distribution
- Change Internals – collectors, electrodes
- Improve Rapping
- Modern control systems
- Increased power: more T/R sets
- High Frequency T/R sets
- Raise the roof
- Additional inlet/outlet fields
- New parallel ESPs
- Conversion to baghouse

# ESP vs. FF COMPARISON

<u>RECENT SEI ESP's</u>		(filterable)	
		<u>SCA*</u>	<u>Outlet</u> <u>lb/mmBtu</u>
Coffeen #2	***		.0048
Duck Creek #3	***		.0047
Tecumseh #9	***		.0038
Thomas Hill #3	***		.0054
<u>Cliffside #5</u>	***		<u>.0066</u>
<b>Average</b>	<b>313</b>		<b>.0051</b>

\*\*\* Proprietary data

\* corrected to 12" plate spacing

# ESP vs. FF COMPARISON

	Yi, Hao, Duan, Li & Guo, 2006	Yi, Hao, Duan, Li & Guo, 2006	Duck Creek
PM SIZE	ESP	FABRIC FILTER	ESP
PM	99.89	99.94	99.91 0.0047 lb/mbtu
PM 10	99.62	99.76	99.73
PM 5	99.16	99.72	99.63
PM 2.5	98.59	99.54	99.37 0.0027 lb/mbtu

# ESP vs. FF COMPARISON

## EXAMPLE #2 (CONT'D)

### SUMMARY – FF RETROFIT

Materials	<u>\$10,230,000</u>
Demo/Installation	<u>\$17,100,000</u>
New ID Fans (installed)	<u>\$ 4,000,000</u>
Boiler Buckstay Upgrade	<u>\$ 6,500,000</u>
Outage	<u>56 days</u>
<u>1<sup>st</sup> Year O&amp;M</u>	
Parasitic Power	<u>\$1,600,000</u>
Routine Maintenance	<u>\$1,400,000</u>

# ESP vs. FF COMPARISON

## EXAMPLE #2 (CONT'D)

### SUMMARY – ESP REHAB

Materials	<u>\$10,500,000</u>
Demo/Installation	<u>\$13,700,000</u>
Outage Duration	<u>56</u> days
1 <sup>st</sup> Year O&M	
Parasitic Power Cost	<u>\$803,900</u>
Routine Maintenance	<u>\$100,000</u>



# Wet precipitators can be part of the most elaborate or simple system

- The ultimate system has an SCR, fabric filter, wet scrubber, and then a final wet electrostatic precipitator
- Often overlooked is the simple option as follows
  - A lime wet scrubber captures particulate and SO<sub>2</sub>
  - A downstream Wet Esp removes the remaining particulate
  - The two can be combined in one tower
- Advantages
  - Low cost and easy retrofit
  - Flyash/lime/gypsum encapsulates the mercury and toxic metals
  - Good landfill material
  - High efficiency

## ***Wet ESP Utility Installations***

<b>Facility</b>	<b>Size</b>	<b>Fuel</b>	<b>APC</b>
AES- Deepwater	155 MW	Pet Coke	WFGD / WESP
Dakota Gasification	420 MW	Waste Liquids	WFGD/ WESP
Dalhousie 1 & 2	315 MW	Orimolsion	WFGD / WESP
Xcel- Shirco	2 x 750 MW	PRB Coal	WFGD/ WESP
NBP- Coleson Cove	3 x 350 MW	#6 Oil	WFGD / WESP
WE- Elm Road	2 x 615 MW	Pittsburgh #8	FF / WFGD / WESP
CWLP - Dallman	200 MW	Coal Blend	FF / WFGD / WESP
LGE - Trimble	820 MW	Coal Blend	DESP / FF / WFGD / WESP
Prairie States	2 x 880 MW	Southern Il. Bit.	DESP / WFGD/ WESP
EKPC - Spurlock	525	Coal Blend	WFGD/ WESP

Wet ESP is effective after a wet scrubber ( Hamon)

**Possible Alternative = WFGD + Wet ESP**

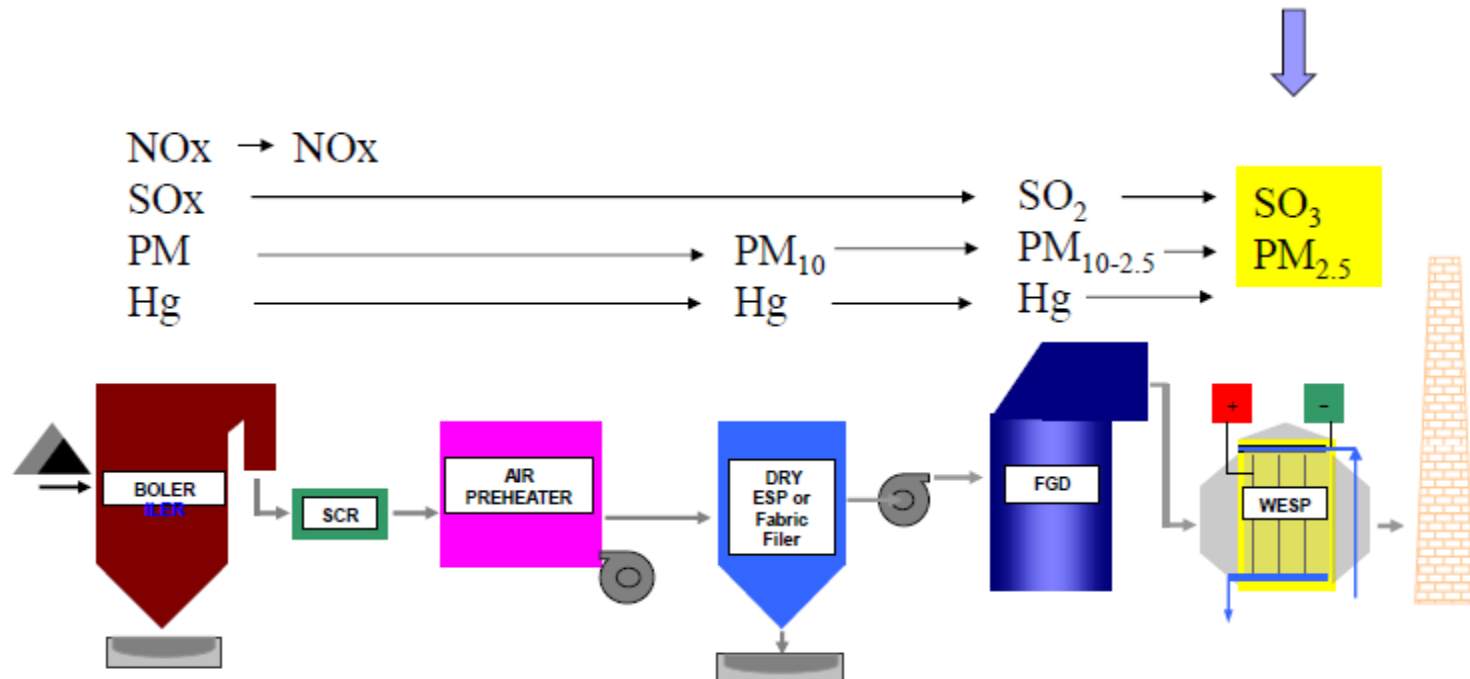

# Wet ESPS for SO<sub>3</sub> and fine particulate

- Several WESPS were installed in U.S. to reduce the SO<sub>3</sub> plume in the period around 2000
- Subsequently the solution to SO<sub>3</sub> was determined to be dry injection
- However, WESPS have been installed on new plants to capture both the SO<sub>3</sub> and fine particulate
- Siemens was the major supplier ( now Foster Wheeler)

# Scrubber capture of fine particulate

- Typical spray tower wet scrubbers do not remove much particulate if there is an efficient precipitator ahead of it
- A tray tower scrubber is slightly more efficient
- During an exceedance the scrubber can remove most of the particles
- At an emission of 0.2 lbs /mm btu from the precipitator, the scrubber will capture more than 0.1 lbs/mm btu
- Wet scrubbers do not remove much SO<sub>3</sub> when it is converted to sub micron hydrochloric acid aerosols
- With the new mass monitoring requirements particulate must be measured in the wet stack following the scrubber
- If the scrubber adds to or reduces the particulate it will now be recorded. Previously opacity monitors prior to the scrubber were the basis of determining exceedances

# Scrubber limitations (Hamon)

## Limitations on WFGD PM<sub>2.5</sub> collection

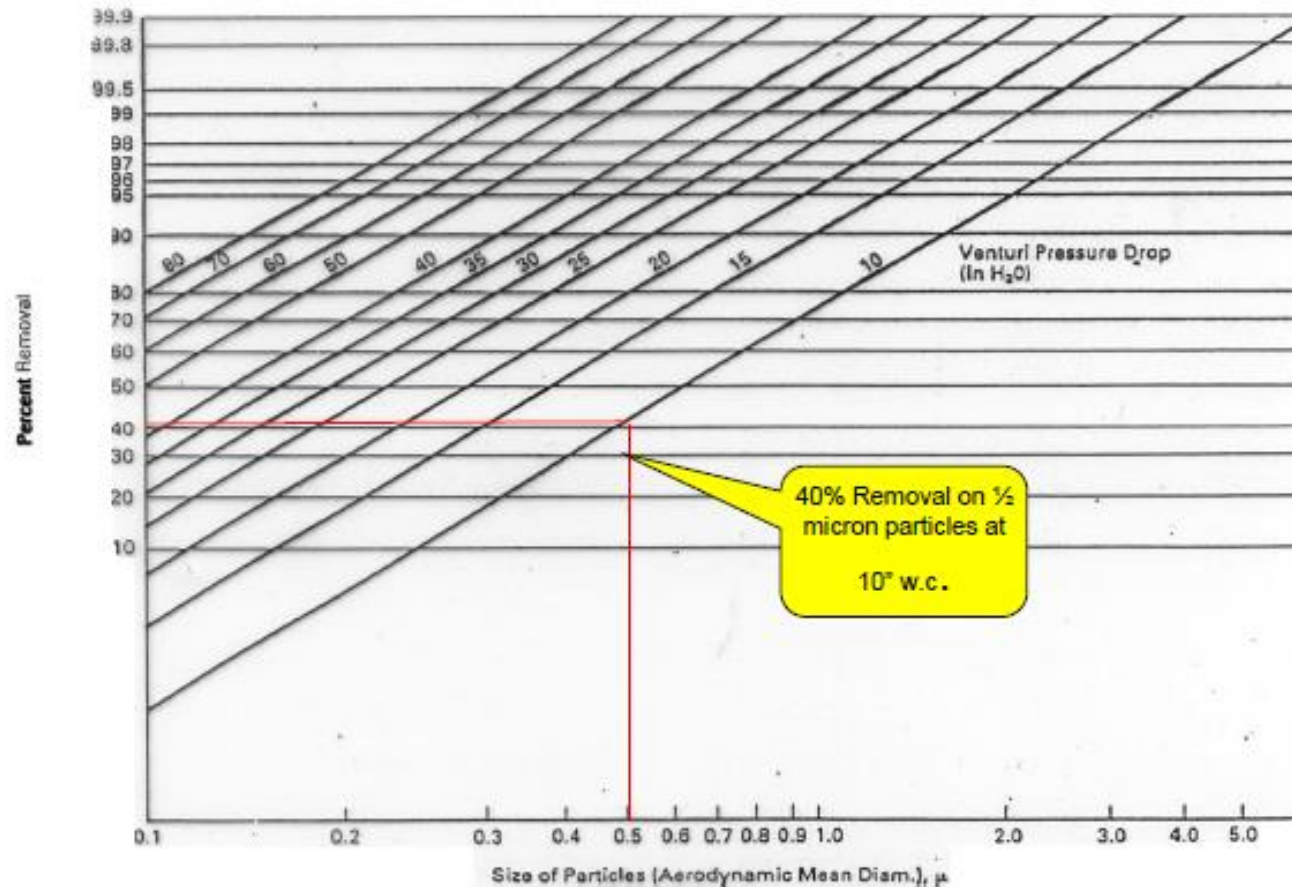

**Will you have to find alternative for H<sub>2</sub>SO<sub>4</sub>**

# Decision Route – Scrubber , Precipitator

## Webinars Protected

Date	Recording tile
October 23, 2014	<b>Dry Scrubbing</b> 104 minutes <a href="#">MORE</a>
October 2, 2014	<b>Precipitator Improvements</b> 84 minutes <a href="#">MORE</a>

## InterWebViews™) free

Date      Subject; company date, language

*( continuing opportunity for suppliers to provide more comprehensive information)*

Decision Orchard key words  
*(access to full data on protected site)*

category	keywords

# SDA followed by bag filter is one of the routes for hot gas filtration and acid gas removal

B&W has a number of spray dryer absorber units followed by bag filters which meet the new Mats filterable PM limits

INSTALLATION	HCl (lb/MBtu)	Mercury (lb/TBtu)	Filterable PM (lb/MBtu)
Walter Scott 4 (790 MW)	0.000038	0.720	0.0034
Weston 4 (530 MW)	0.000077	0.893	0.0066
TS Power Project (220 MW) (Newmont Nevada Energy)	0.000022	0.867	0.0056
Hawthorn 5A (540 MW)	0.000072	5.30	0.0011
Spruance Genco 2 (57 MW) (Coal-and tire-firing)	0.000017	0.0026	0.0183
<b>MATS Limits</b>	<b>0.002</b>	<b>1.2</b>	<b>0.030</b>

**SDA units supplied by B&W are meeting MATS compliance**



# Fabric Filters for hot gas filtration

- Fabric filters can be prior to or after the SO<sub>2</sub> scrubbing device
- Various cleaning mechanisms impact bag and media selection
- A range of fibers and media is available depending on widely varying site specific conditions

# One option is a low pressure long bag design

## Recent Trends in Fabric Filters

KC Cottrell Inc. 

- Low pressure pulse, long bag design
- Online cleaning
- No bypass on start-up
- Filter as reactor (primary or secondary)
- Increasingly lower emission rates
- Use of PTFE membranes

# Bag material considerations-KC Cottrell

## Bag Material Considerations

KC Cottrell Inc. 

- Operating temperature
- Moisture
- Chemistry
- Abrasion resistance
- Filtering Mechanism
  - Depth vs. Surface Filtration

# ENEL has converted ESPs



Fabric Filters running in Enel's national fleet



Plant	Capacity (MWe)	FF type	Installation	Supplier	Year	Bag Length [m]	Comp.	Emissions guarantees [mg/Nm <sup>3</sup> ] (°)	Expected FF Emiss. in Operation [mg/Nm <sup>3</sup> ]
Fusina 1&2	2 x 160	PJ, HP/LV	Conversion	TMK	1999	8,5	2	<30	<15
Genova 6	160	PJ, HP/LV	Conversion	TMK	2003	9	4	<30	<15
Sulcis 2 (*)	340	PJ, HP/LV	New (**)	Aster	2005	8,5	16	<25	<15
Torrevald. 1÷3	3 x 660	PJ, HP/LV	New (**)	TMK	2005	8	16	<10	<9
Brindisi S.# 3&4	2 x 660	PJ, HP/LV	Conversion	TMK	2010-12	8	4	<20	<10

(\*) Circ.Fluid.Bed Boiler (CFB)      (\*\*) Over the existing Electr. Precip. ESP foundations      (°) hourly basis

- Italian references regarding conversions from electrostatic precipitators (ESPs) to fabric filter (FFs) are all “brown field” installations.
- “Conversion” means “transformation” from an electrostatic precipitator to a fabric filter using the previous casing.
- “New” fabric filters → to use only the existing foundation of the old previous electrostatic precipitator and to design new filter steel structure and casing.
- There is in addition a small fabric filter installed in a ~ 30 MWe Biomass PP in Calabria (South of Italy)

Acronym: PJ pulse jet; HP/LV high pressure low volume type; ESP Electrostatic Precipitator; TMK Termokimik spa ;  
Torrevald.: Torrevaldaliga North power plant.

# Enel has FF on boilers in Russia, Chile, Spain ( Evonik presentation)



## Fabric Filters in Enel's abroad fleet and programs



Plant	Country	Capacity (MWe)	FF type	Installation	Supplier	Year	Bag Length [m]	Comp.	Emissions guarantees [mg/Nm <sup>3</sup> ]	Expected FF Emiss. in Operation [mg/Nm <sup>3</sup> ]
Alcudia	Spain	2 x 125	PJ, HP/LV	New	Fisia Babcock	n.a.	8	6	<20	<15
Alcudia	Spain	2 x 130	PJ, IP/IV	New	ABB/BWE	n.a.	7	6	<20	<15
Tarapacà	Chile	158	PJ, IP/IV	New	ALSTOM	2013	10	8	<10	<10
Bocamina I	Chile	128	PJ, IP/IV	New	ALSTOM	2007	8	6	n.a.	20
Bocamina II	Chile	350	PJ, HP/LV	New	Slavex	2012	6,5	20	<30	<15
Reftinskaya 5	Russia	300	PJ, IP/IV	Conversion	ALSTOM	2013	8	4	<50	<20
Reftinskaya 7	Russia	500	PJ, HP/LV	Conversion	Clyde Bergmann	2014 (*)	8,5	16	<50	<20
Reftinskaya 4	Russia	300	PJ, IP/IV	Conversion	ALSTOM	2015 (*)	8	4	<50	<20

(\*) Note: expected date / schedule to be confirmed.

- The filters in Russia could be taken as the more challenging in terms of operation and maintenance considering the very high dust content of the coals (up to 40%) and the high NOx inside the flue gas.
- About the remaining units in Russia: #1 ÷ 4 and #8 ÷ 10 the conversion of the existing electrostatic precipitators ESP to fabric filters FF are today foreseen before the end of this decade.

*Other Acronym: HP/LV High Pressure Low Volume type, IP/IV intermediate Pressure - Intermediate Volume, n.a. not available*

# Eskom will be spending \$ 100 million/yr for bags (Evonik Presentation)

## Fabric Usage Forecast following FFP Retrofit

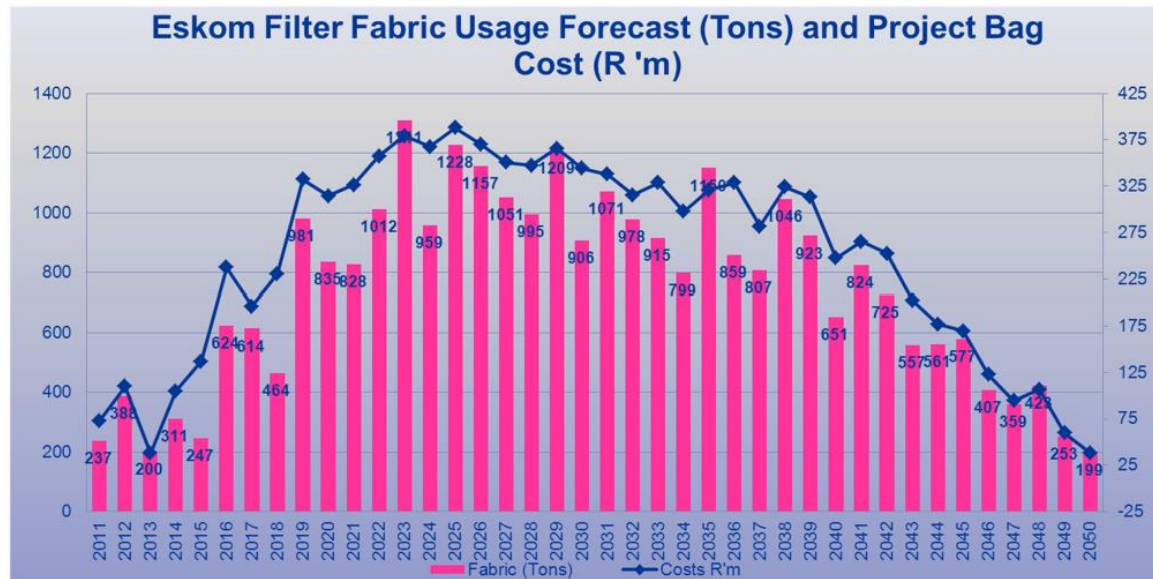

This equates to an average consumption of approx. 350 000 bags per year.  
Currently all bags are disposed of in a Class H:H Hazardous Waste Dump at Holfontein  
(350 000 bags = +1 000 000 m<sup>2</sup> of fabric)

# Tubular bags

Tubular bags remain the major choice for higher temperature conditions and heavy dust loadings.

Pleated bags are more expensive and are generally used where space is tight

The main use of wovens is in glass bags with reverse air cleaning.

Most tubular bags are non-woven felts.



## Pleated Bags

Pleated bags are being used mostly for retrofit installations where more gas flow is needed or there is a need to reduce pressure drop. Cost is a consideration for new installations as well as ease of cleaning. So issues are

- Space available
- Pressure drop
- Cost
- Cleanability

**Key words:** [Pleated Bags](#)





**With StarBags, power plants can achieve reduced particulate emissions and lower their usage of activated carbon and lime**

- SOLAFT Filtration Solutions, pioneered the development of StarBag™ technology in the early 2000s as developer and patent holder of StarBags™ with the first smelter wide installation at Boyne Smelters in 2004
  - Since then, StarBag™ Solutions have become common in smelters worldwide helping smelters deliver meaningful operational improvements with a strong return on investment (ROI) and relatively short payback period
  - StarBag™ Solutions are installed in filtration systems replacing standard filter bags without any expansion or change to the design of existing bag houses other than a change to the supporting cages
- With StarBags™ and SOLAFT's expert support, benefits achieved for smelters can be realized by power generators:
    - Reduced particulate, Hg and SOx emissions
      - Reduced lime and activated carbon usage
    - Increased generation where ID fans are a constraint to air flow
    - Compliance with MATS and operating licenses
- StarBag™ Solutions deliver these benefits by increasing filtration area, thus enabling increased gas volume and particulate load through the bag house while at the same time reducing differential pressure
  - SOLAFT can work closely with power generators around the world to understand their commercial challenges and can configure a StarBag Solution to overcome their challenges and deliver meaningful benefits

## New Developments in Fabric Filtration

We are working closely with power generators, fibre makers, chemists and technologists around the world to bring the most recent thinking and developments to our customers

	Emerging Trends	Product Approach	Our solution
1	High efficiency filtration with stratified fabrics of multi-lobal fibres	PPS inner web with multi-lobal P84 fiber in the face to lower emissions and reduce pressure drop, lowering operating costs and lengthening bag life	PrimaLobe
2	Extending life by combating oxygen degradation with new fibres	New fibres with superior resistance to oxidation are being trialled with promising results	PrimaOxyTech
3	Fabrics for aggressive acid and non-agglomerating and high velocity dusts	Use of PTFE fiber blended with PPS to resist acid degradation and minimise impact of poor dust cake formation	PrimaGlide
4	New software to track bag life, predict bag change-outs and managing bag house operations	Software and product solutions enabling each individual filter bag's performance to be tracked	FilterFacts
5	Extended surface area bags to lower emissions with lower differential pressure and increased flows	Extended surface area bags achieve reduced emissions from reduced pulse frequency	Star Bags

Private

# Relative bag costs

## Cost Considerations

- ◆ Current pricing per bag, 33' long by 5" diameter:
  - PPS Felt ~ \$81-90
  - P-84 Felt ~ \$143-158
  - WFG/Membrane ~ \$73-81



# Parameters affecting media selection

Subject	options					
fiber	pps	P84	ptfe	glass	ceramic	acrylic
media	Non woven	Membrane laminate	woven	sintered		
Plant conditions	Emission limit	Area available	Fan limits	Mercury removal	SCR	FGD
gas	Flyash load	Sulfuric acid	Sulfates/	Activated carbon	temperature	Other acid gases
Bag shape	Tubular	Pleated	cartridge			
cleaning	Hi vol med Pressure air	High pressure air	Reverse air	shaker		

# Needlefelts: Finishing and Treatments for CFB

	<i>Description</i>	<i>Fibers</i>	<i>Benefit</i>
<b>ePTFE MEMBRANE</b>	Expanded PTFE membrane laminate on the dust side	PAN, PPS, P84, GLASS, PTFE	<ul style="list-style-type: none"> <li>- Controlled low emissions</li> <li>- Better efficiency</li> <li>- Cleanability</li> <li>- <b>Disadvantage:</b> abrasion, oils, special install, tight fit</li> </ul>
<b>KLEENTES</b>	- Fluorinated resins for bath impregnation of the felt	PAN	<ul style="list-style-type: none"> <li>- Water repellency</li> <li>- Better cake release</li> <li>- Suitable for sticky dust</li> </ul>
<b>MANTES</b>	-PTFE resins for bath impregnation of the felt	PAN, PPS, P84, PTFE	<ul style="list-style-type: none"> <li>-Water and oil repellency</li> <li>- Very good cake release</li> <li>- Increased bag lifetime</li> <li>- Adds surface area</li> </ul>
<b>RHYTES</b>	-Fluorinated and PTFE resins (high concentration) for bath impregnation of the felt	PAN, PPS, P84	<ul style="list-style-type: none"> <li>- Water and oil repellency</li> <li>- Better cake release</li> <li>- Suitable for sticky dust</li> </ul>
<b>SUPERNOVATES</b>	- Copolymer foam deep coating suitable for temperature up to 200°C	PPS	<ul style="list-style-type: none"> <li>- Better filtration efficiency</li> <li>- Very low emissions below 5mg/Nm<sup>3</sup></li> </ul>

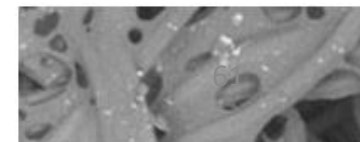
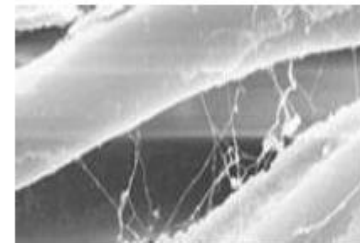
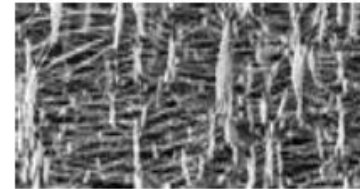

# Membrane laminate has higher efficiency on smaller particles particularly prior to loading

## Efficiency Comparison: 16oz PPS

### Conventional Media

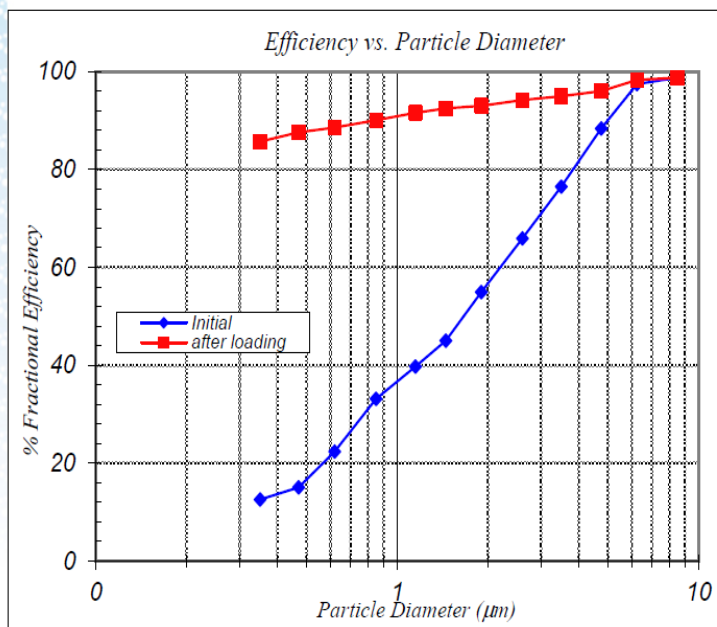

### Tetratex Laminate (8162)

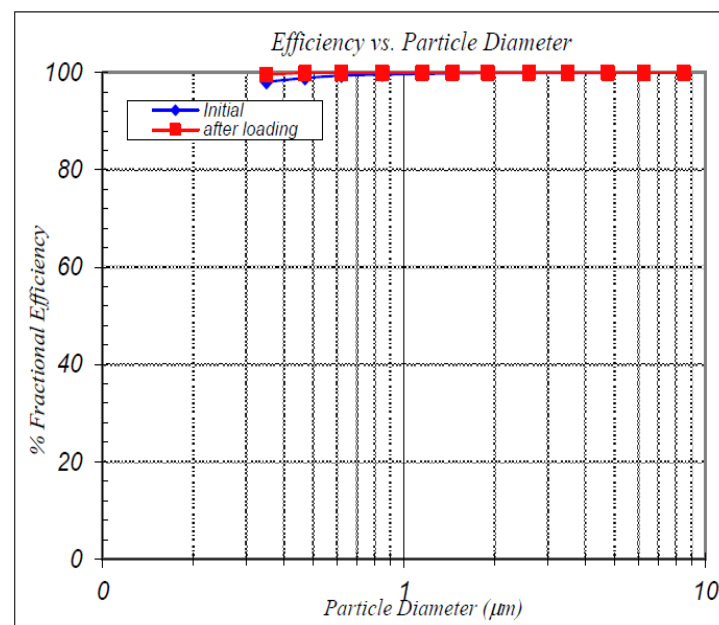

\* Independent test results conducted by LMS Technologies Inc. May 2012



Committed To Solving Your Filtration Challenges





# Donaldson cites depth filtration disadvantages

## Conventional Filter Media: Depth Filtration

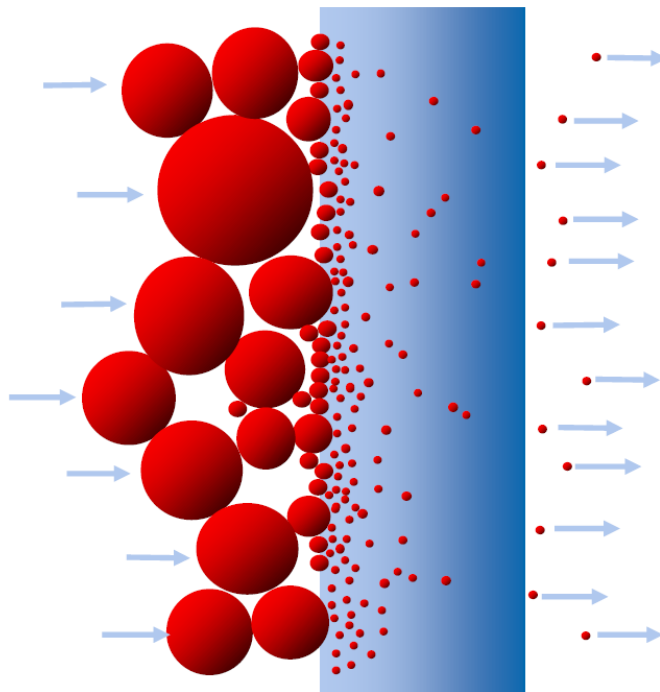

- Efficiency relies on primary cake formation
- Dust cake restricts airflow
- Requires high cleaning energy, which impacts mechanical stresses
- Fine particles migrate into media causing abrasion damage
- Leads to blinding - High pressure drop

# Media selection-Testori

## Selecting Media

FILTER MEDIA SELECTION CHART FOR POWER						
FIBER TYPE	COMMON BRAND NAMES	TEMP LIMITS* F/C	RESISTANCE TO ACIDS	RESISTANCE TO ALKALIS	RESISTANCE TO HYDROLYSIS	RESISTANCE TO OXIDATION
COTTON	NA	180°/85°	Poor	Good	Good	Good
PVC	Rhovyl, Clevyl	150°/65°	Excellent	Excellent	Excellent	Excellent
POLYPROPYLENE	Herculon	190°/90°	Excellent	Excellent	Excellent	Poor
NYLON	Enka, Antron	230°/110°	Poor	Excellent	Poor	Good
HOMOPOLYMER ACRYLIC	Dolanit, Aksa	257°/125°	Good	Fair	Good	Good
POLYESTER	Fortrel, Dacron, et al.	300°/150°	Good	Poor	Poor	Good
PPS	Torcon, Procon, et al.	375°/190°	Excellent	Excellent	Excellent	Fair
ARAMID	Nomex, Conex, et al.	400°/205°	Poor	Excellent	Poor	Fair
POLYIMIDE	P84	450°/235°	Fair	Poor	Good	Good
PTFE	Profilen, Toyoflon, et al.	500°/260°	Excellent	Excellent	Excellent	Excellent
FIBERGLASS	NA	550°/285°	Good	Fair	Excellent	Excellent

\*Dry heat only

Testori USA, Inc.  
www.testori-usa.com



# Range of membrane efficiencies

## Tetratex<sup>®</sup> Membrane Products *Particular to the Challenge*

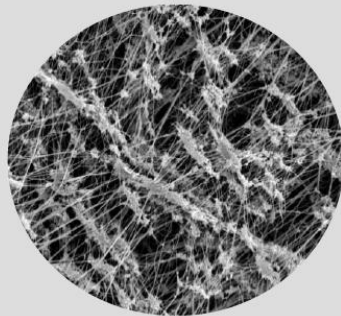

**Tetratex**

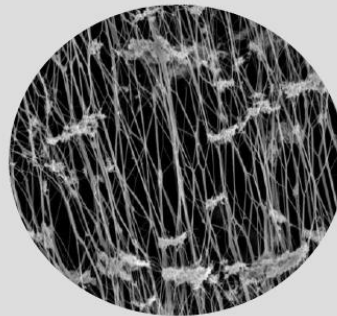

**Tetratex  
EXTREME<sup>®</sup>**

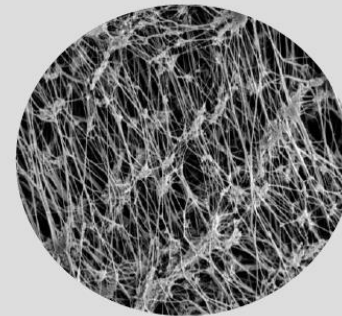

**Tetratex  
High Efficiency**



*Committed To Solving Your Filtration Challenges*



# Pleated bags - membranes key words [Midwesco Pleated Bags](#) [Particulate and Condensable Removal - Pleated Products by Tom Anderson, TDC Filter](#)



Parameters	Spun Bond Polyester with High efficiency ePTFE Membrane	18-20 Ounce Polyester Felt
PM 2.5 Emissions (g/dscf)	.00000073	.0000073
Total Mass Emissions:	.0000073	.0000073
Avg. Residual Pressure Drop (cm w.g.)	1.40	2.67
Filter Sample Weight Gain (grams)	2.67	8.64
Avg. Filtration Cycle (secs.)	154	37
Number of Pulses	142	558

# *microvel*<sup>®</sup> - Near zero emissions and low dp using fine fibres and Gutsche manufacturing expertise

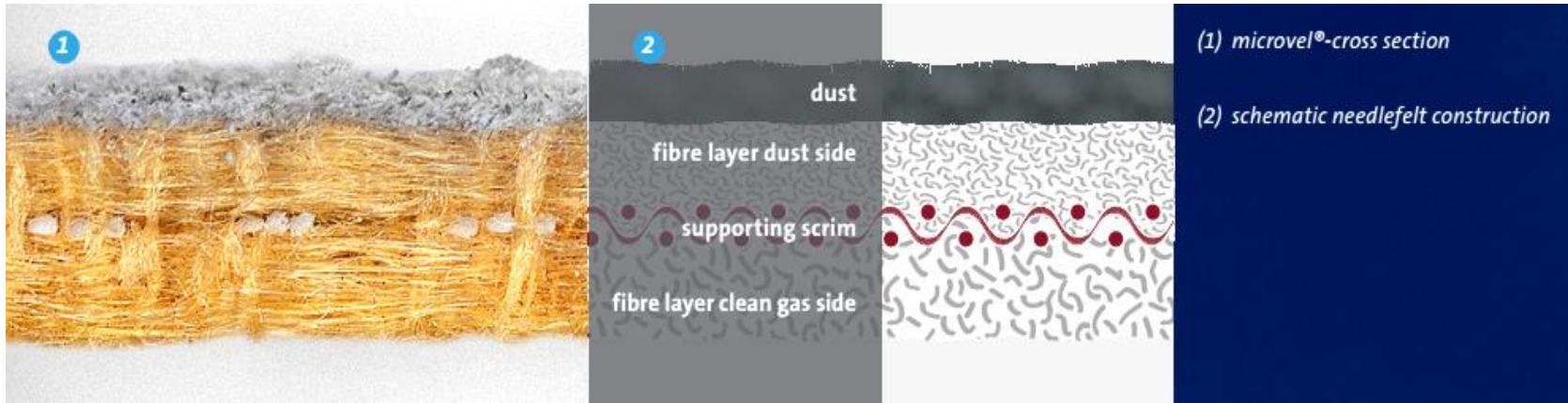

## ***microvel*<sup>®</sup> - overview of advantages:**

- extremely low outlet emissions
- very good regeneration capabilities leading to low dp
- high mechanical stability
- problem free installation with no special tools
- optimal cost-benefit ratio
- excellent case histories and references

# *optivel*<sup>®</sup> - An optimal combination blending different polymers to achieve the best results

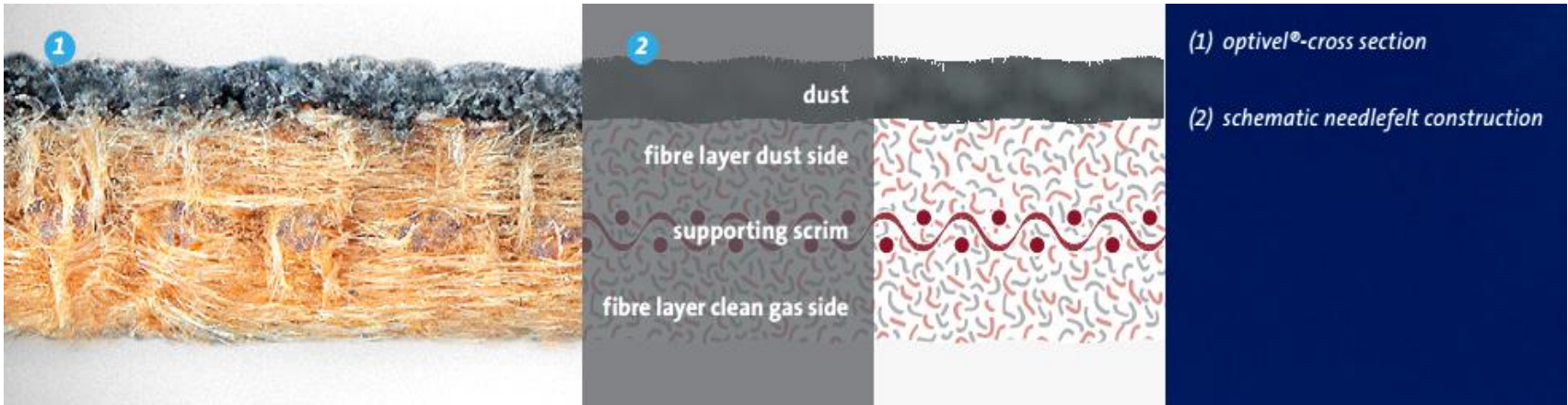

## ***optivel*<sup>®</sup> - overview of advantages:**

- improved separation efficiency
- optimal cost-benefit ratio
- combination of fibre strengths
  
- high mechanical stability
- optimal filter cake build-up
- world class reference list
- low dp and emissions

# *microvel*<sup>®</sup> & *optivel*<sup>®</sup> - Filter media in filtration mode

Optimal filter cake build-up

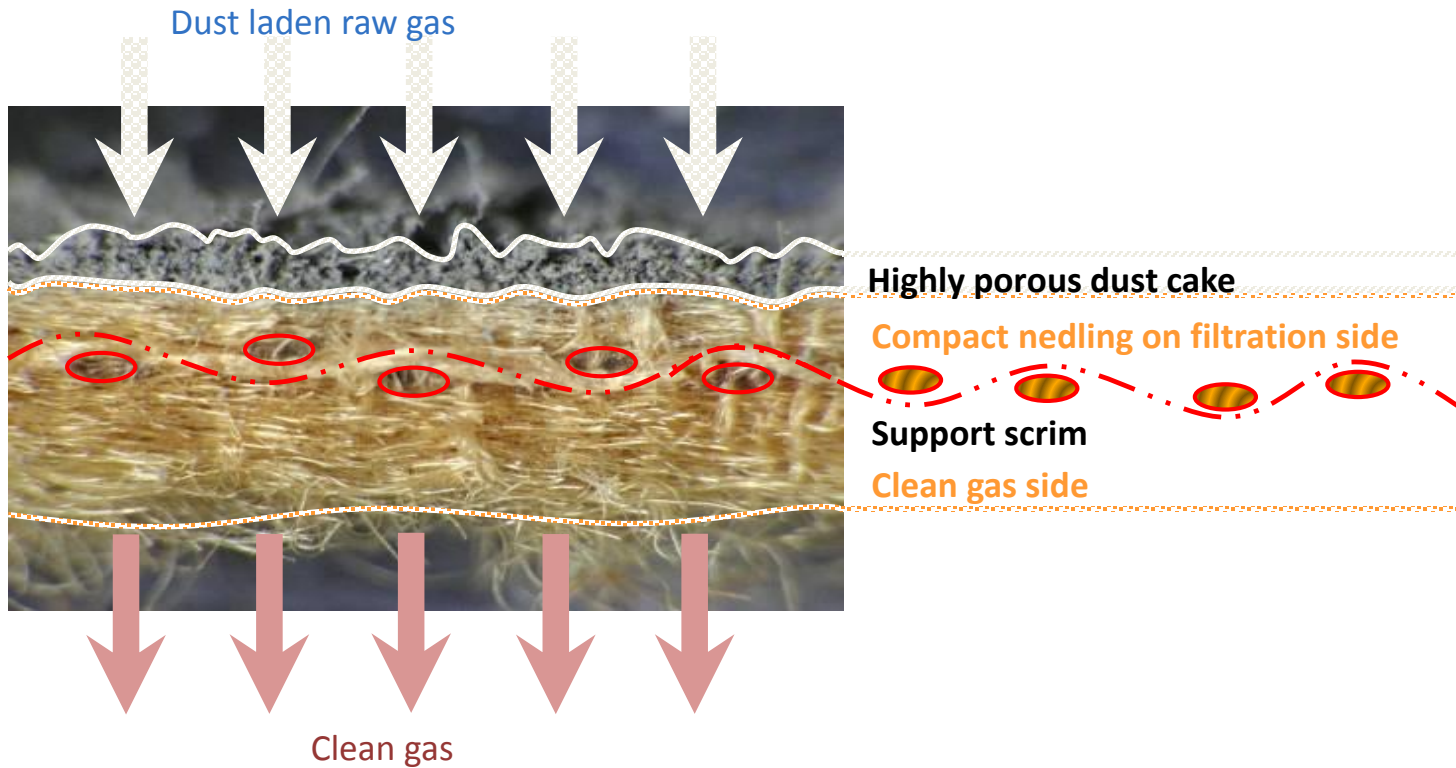

# Decision Route – Fabric filter Media

## Webinars Protected

Date	Recording tile
October 23, 2014	<b>Dry Scrubbing</b> 104 minutes <a href="#">MORE</a>
January 8, 2015	<b>Fabric Selection for Hot Gas Applications</b> 120 minutes <a href="#">MORE</a>

## InterWebViews™) free

Date	Subject; company date, language
<i>( continuing opportunity for suppliers to provide more comprehensive information)</i>	

## Decision Orchard key words *(access to full data on protected site)*

category	keywords

# Ceramic and Metal Filters

Subject	Author	Relevant decision
Catalytic filter with powdered limestone	Durr	
Catalytic filter-ceramic and 3 layer	Haldor Topsoe	
Catalytic filter	Tri-mer	
Metal filters	Purolator	



# Catalytic filter with embedded catalyst

Filter Element

## UltraCat Catalyst Filter: Structure and Size



Nano-bits of NO<sub>x</sub>, CO, VOC catalyst are embedded into the walls and adhere to the fibers.

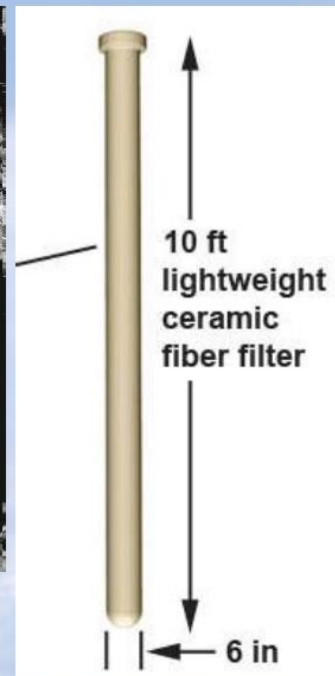



# Cleaning & Pressure Drop vs. Competition

Parameter	Clear Edge Cerafil	Competiton
<b>Porosity</b>	80% (dense outer wall)	90% (open outer wall, dense inner wall, gradient)
<b>Filtration</b>	Mainly on the conditioned outer surface	First dust penetration and then filtration
<b>Dust penetration</b>	0.63 mg	5.03 mg
<b>Pressure drop rise</b>	Gradual	Quick
<b>Cleaning cycle interval</b>	Long	Short
<b>Time to 4kPa</b>	6 times longer	1x
<b>Cleaning interval</b>	Over 5 times longer	1x

VDI 3926/ASTM D6830-02: Testing for cleanable filter media

# Cerafil TK-3000 - Long term performance

## Glass Furnace

**Application:** Glass furnace exhaust

**Cerafil TopKat-3000:** 1700 elements

**Commissioned:** Sep 2009

**Volumetric flow:** 53,000 scfm (85,000 Nm<sup>3</sup>/h)

**Operating temp:** 615°F-660°F (325°C – 350°C)

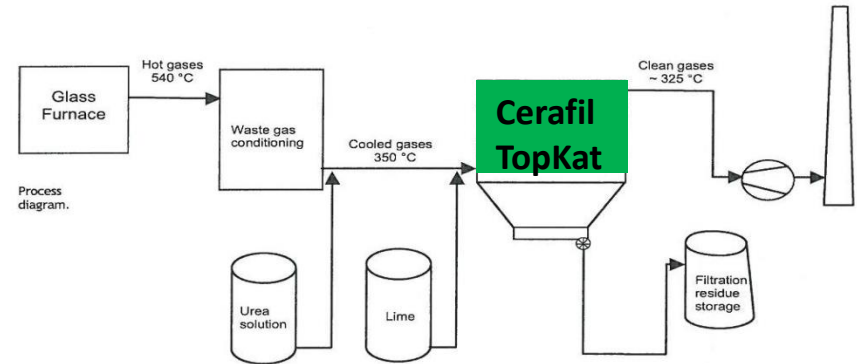

Year	Dust (mg/m <sup>3</sup> )	*NO <sub>x</sub> (mg/m <sup>3</sup> )	*SO <sub>x</sub> (mg/m <sup>3</sup> )
2012	<10	<600 mg/m <sup>3</sup>	<400 mg/m <sup>3</sup>
2013	<10	<600 mg/m <sup>3</sup>	<400 mg/m <sup>3</sup>
2014	<10	<600 mg/m <sup>3</sup>	<400 mg/m <sup>3</sup>

\*Permitted limits: NO<sub>x</sub>: 800 mg/m<sup>3</sup> and SO<sub>x</sub>: 800 mg/m<sup>3</sup>

# Existing U.S. Coal-Fired Boilers

Side Stream Application – Example existing ESP

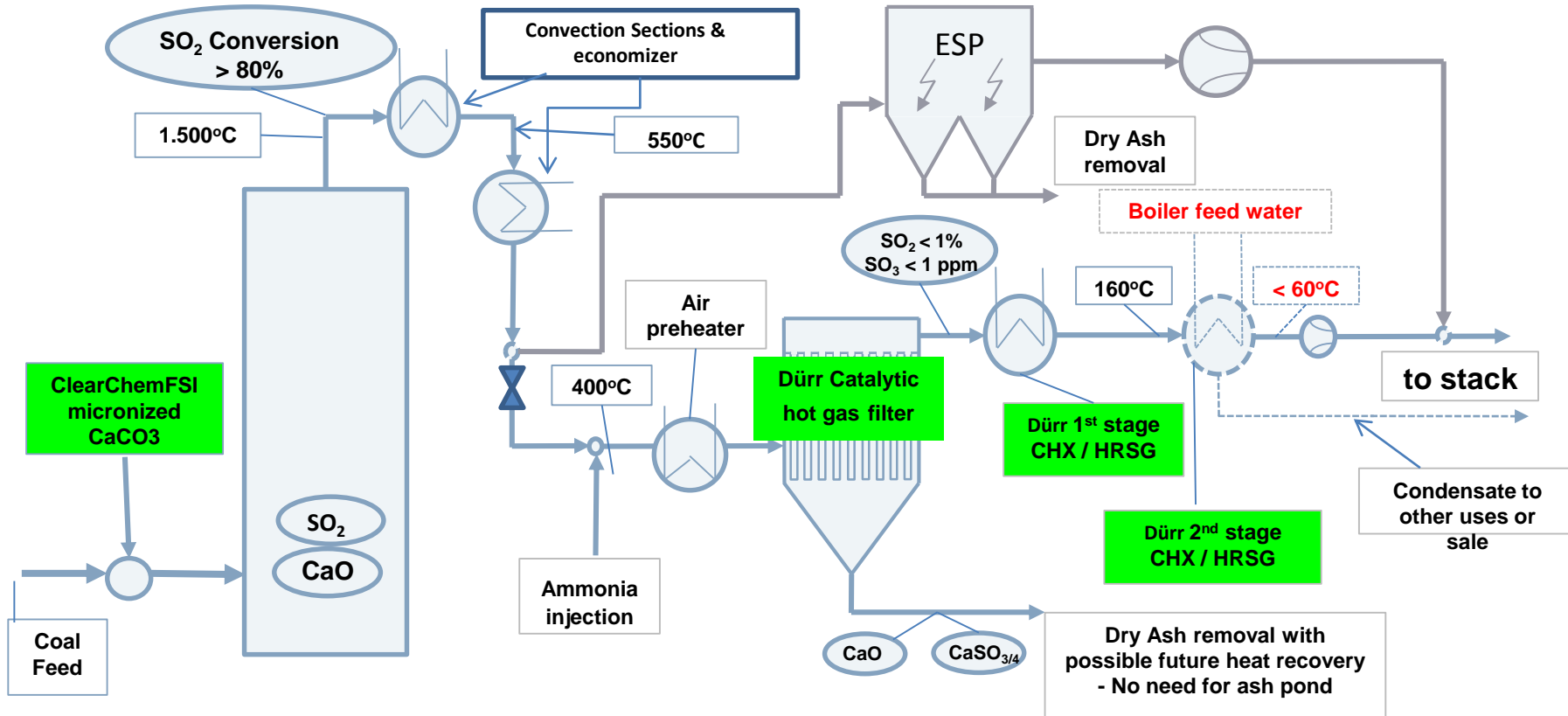

# Purolator metal elements

Purolator: technological leadership in turnkey units design  
Porofelt® medium ... to ... Poroflow® HG Elements

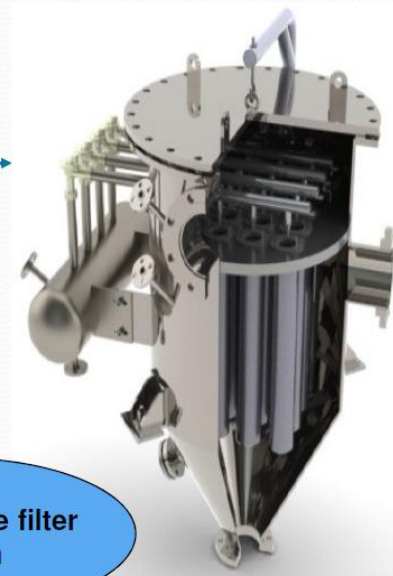
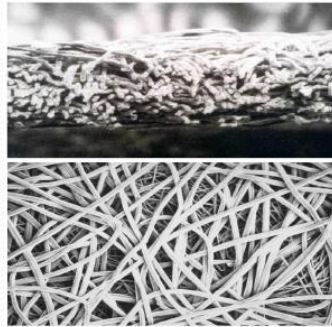

Selection of a filter element

Design of the filter system

# Sintered or fiber mesh

## Purolator: Filter media technologies

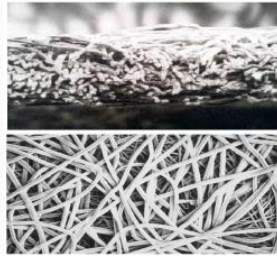

Product **Sintered fibre Porofelt®**

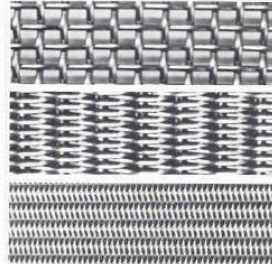

Sintered mesh Poroplate®

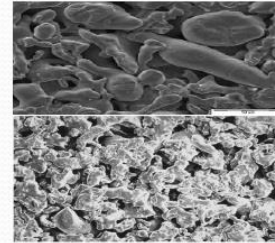

Sintered metal powder

Porosity **60 to 85 %**

10 to 45 %

**30 to 35 %**

- **Benefit of low pressure drop**
  - less blow back gas needed;
  - less usage of blow back valves;
  - lower energy consumption of fans;
- ... makes it also possible to use higher face velocity
  - less filtration area
  - lower footprint



# Sintered metal fiber advantages over powder

**Purolator: Filter media technologies**

Flow in with dust

Sintered Fibre  
thin and multilayer

Sintered Powder  
thick & monolayer

**Sintered Metal Fibre**

- ✓ Less clog: the very few particles passing the fine top layer will not be blocked through coarser support layers
- ✓ Superior BB: less energy needed to reach the cake on medium surface

5 Purolator Advanced Filtration 2015

**Purolator**  
ADVANCED FILTRATION  
a CLARCOR company

# Metallics can achieve high capture but performance on specific applications is more relevant

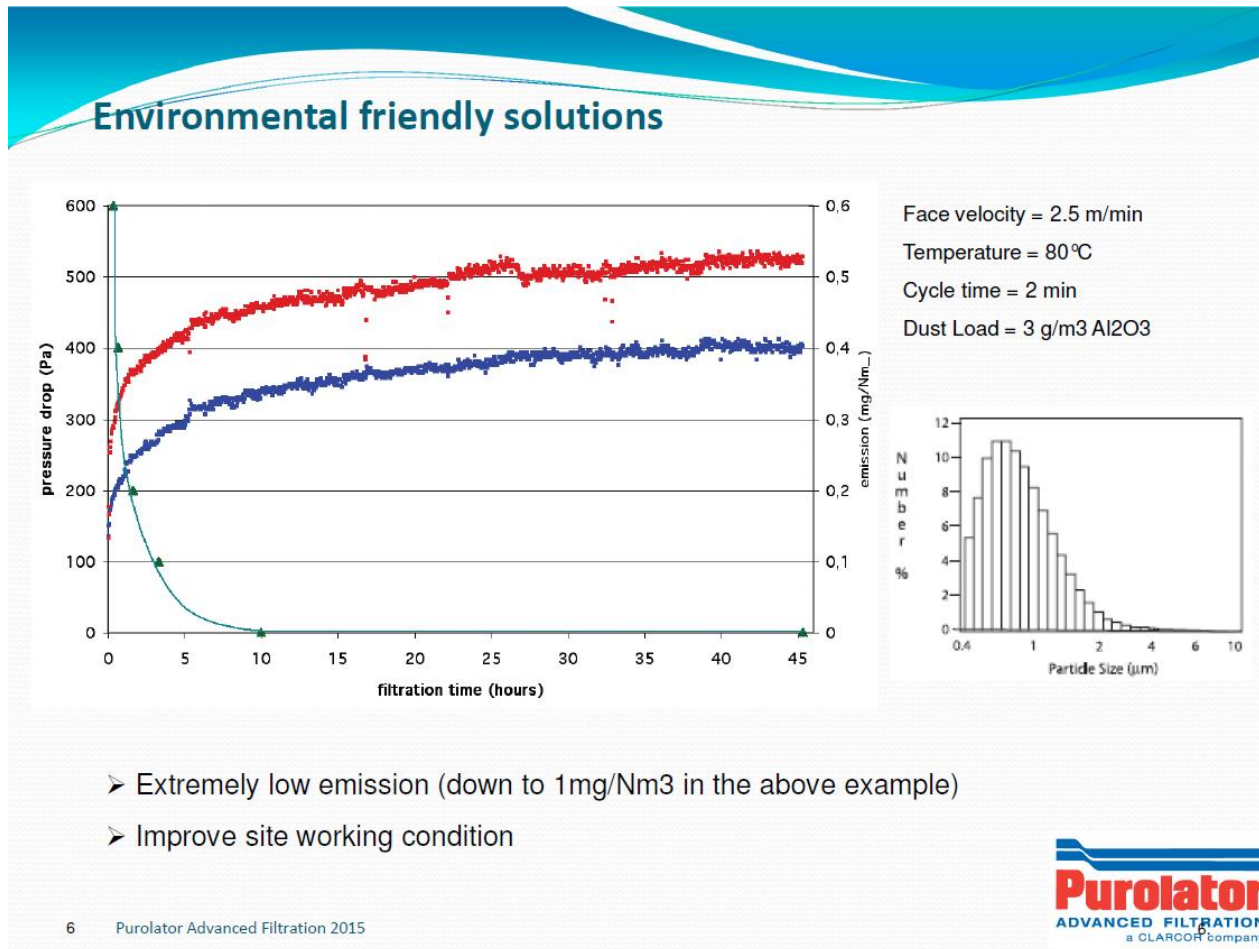

# High capture rate for 1 micron but what about sub micron fume?

## Purolator Advanced Filtration: USP in gas applications

- ▶ Clean gas for emissions
- ▶ Catalyst recovery
- ▶ Product recovery

- **High Efficiency** for fine particles 99,9995 % @ 1 $\mu$ m
- **Emissions** < 1 mg/Nm<sup>3</sup>
- Lower clean pressure drop (<10 mbar) → **longer cycle time**
- **Higher Flowrate** or **smaller vessel footprint**
- **Lower blow-back gas consumption**
- **Reliability & Lifetime** : less process interruptions, downtime & maintenance
- **Corrosion, high Pressure & Temperature Resistance** - depending on alloy : up to 800°C
- **Cleanability** - Cleaning in Place (CIP), backpulsing
- **Fully Sintered & Welded** - no binder, no glue, no contamination
- **Rigid & shock resistant (mech & therm)** - not brittle, no medium migration

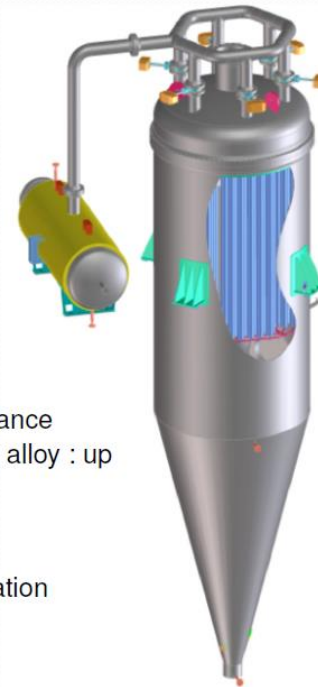



# Coal gasification is one successful application for metallic on large units

## Where? ... Applications & industries

- **Oil Refinery**
    - Fluid Catalytic Cracking
    - Catalytic Reforming
    - Catalytic Dehydrogenation
  - **Chemical**
    - Polyethylene
    - Polypropylene
    - Nitric Acid (*Fertilizers*)
    - Melamine (*PU Resins*)
    - Aniline
    - Acrylonitrile
    - Diphenol
    - Hydrogen Cyanide (HCN)
    - Caprolactam
    - Maleic Anhydride / Butandiol
    - PVC (VCM / EDC)
  - **Natural & Technical Gases**
- **Gasification**
    - Coal Gasification
    - Biomass Gasification
  - **Ore Smelters dedusting**
    - Bauxite (Al)
    - Copper (Cu)
    - Platinum (Pt)
    - Nickel (Ni)
  - **Other calcination processes**
    - Titanium Dioxide (TiO<sub>2</sub>)
    - Calcium Oxide (CaO)
    - Magnesium Oxide
  - **Dedusting and Energy Recovery**
    - Cement
    - Steel

+ **Engineering companies** &  
+ **Filter Industry** (System Manufacturer)

# Decision Route – Metal and Ceramic

## Webinars Protected

Date	Recording tile
October 23, 2014	<b>Dry Scrubbing</b> 104 minutes <a href="#">MORE</a>
January 8, 2015	<b>Fabric Selection for Hot Gas Applications</b> 120 minutes <a href="#">MORE</a>
<b>InterWebViews™) free</b>	
Date	Subject; company date, language
<i>( continuing opportunity for suppliers to provide more comprehensive information)</i>	

## Decision Orchard key words *(access to full data on protected site)*

category	keywords
Product	Catalytic filter, metal, ceramic
companies	Durr, Filtration Group, Haldor Topsoe, Purolaor

# materials

- Resins
- Fibers
- Sorbents
- Coatings
- Substrates
- adhesives

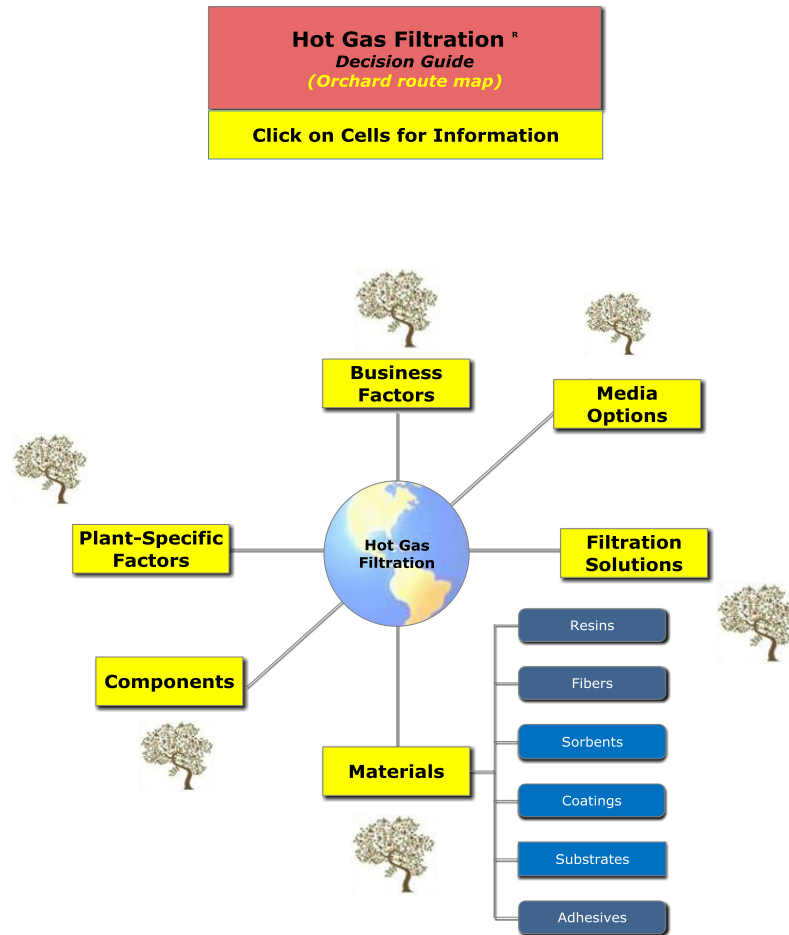

# Resins and fibers

- The selection of filter bags is highly influenced by the cost and performance of the resins and fibers used
- Some suppliers supply both resins and fibers. Others such as Evonik sell fibers but buy the resins (Evonik PPS resin is supplied by Toyobo)
- The price and availability of PPS market is made more uncertain by the huge potential demand for power plant filters e.g 40,000 tons per year or more
- The financial problems of Lumena, a large PPS supplier in the Chinese market make the price and availability in this market more volatile.
- New DSI technology allows the temperature and acidity to be controlled. So this cost needs to be weighed against the differences in fiber and media costs.
- The synthetic media/catalytic bag such as the three layer FLS/Haldor Topsoe offers the opportunity for higher temperature fibers e.g P84 to be used

# Fiber shape-Testori

Typical fibers for CFB: cross section shapes

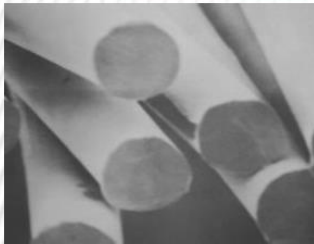

ROUND  
PPS / PTFE

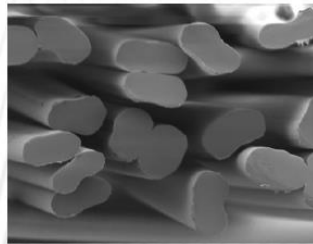

DOG BONE  
PAN



TRILOBAL  
PPS

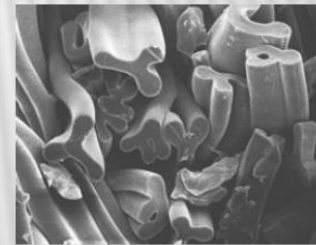

MULTILOBAL  
P84<sup>®</sup>

HIGHER FILTERING SURFACE  
(considering the same titre)

$m^2/kg$

STANDARD  
SHAPED FIBERS

MORE SURFACE AREA = INCREASED FILTRATION  
EFFICIENCY IN SAME BASIS WEIGHT FELT



# Dust Collector Fiber Options

## Material Characteristics

Fiber Type	Maximum Operating Temperatures Degrees F (C)		Chemical Resistance						
	Dry Heat	Moist Heat	Strong Acids	Weak Acids	Strong Alkalis	Weak Alkalis	Solvents	Oxidizing Agents	Hydrolysis
UHMWPE	176 (80)		****	****	****	****	****	****	****
Polypropylene	200 (93)	200 (93)	****	****	****	****	****	***	****
Polyester	275 (135)	200 (93)	***	***	*	**	***	****	*
Nylon (Polyamide)	250 (121)	225 (107)	*	***	***	***	***	***	**
PTFE	500 (260)	500 (260)	****	****	****	****	****	****	****
Glass	500 (260)	500 (260)							

Hydrophobic versus Hydrophilic  
Oleophobic versus Oleophilic



# Fiber Blends for coal fired boilers

## Main Fiber Blends for Coal Fired Boilers

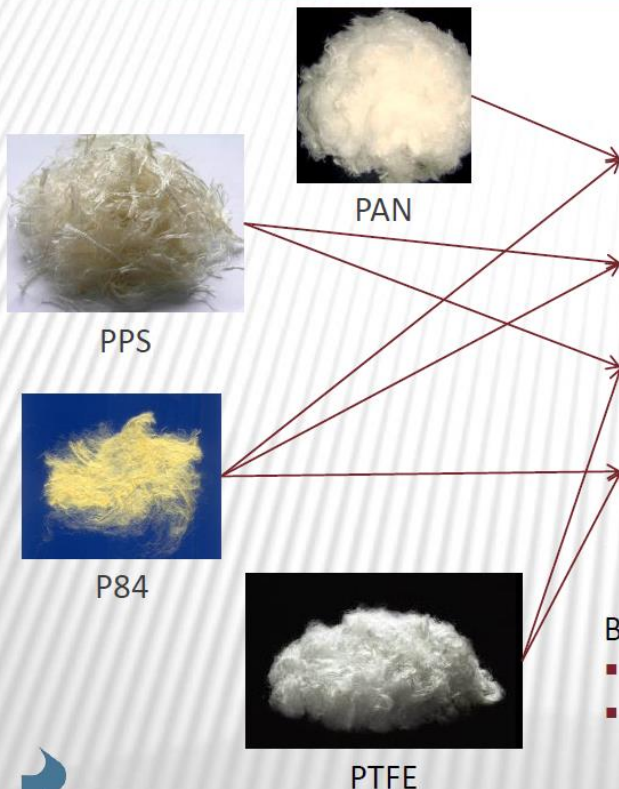

### Testori code

PAN/P84 (DX)

PPS/P84 (SX)

PPS/PTFE (SF)

P84/PTFE (XF)

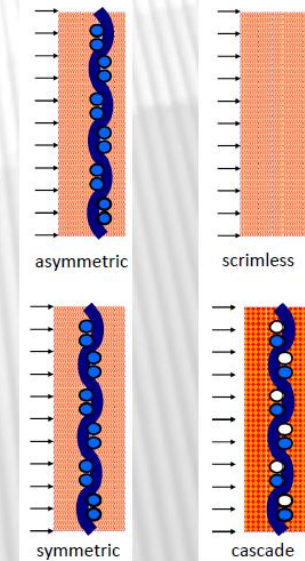

Blends are designed to be:

- combination of different fibers in the batt
- combination of batt and scrim made with different polymers

# High temperature fiber options



## FF: Fabric types

Table 3 Fabric types (Stark, 2012; Popovici, 2011; Johnson and McMenus, 2011)

Name	Maximum operating temperature	Remarks	Relative cost
Acrylic felt (PAN or polyacrylonitrile)	130°C	Lowest maximum operating temperature.	£
PPS felt (Polyphenylenesulphide)	190°C	Degrades at higher temperatures with >12% oxygen. Resist chemical and thermal attack. Effective when laminated with ePTFE.	££
Aramid felt	204°C	Not as capable as PPS in chemically active flue gas	£££
Woven fibreglass	260°C	Fragile, require tight tolerances. Suitable with reverse-air cleaning systems.	£
P84 felt by Evonik Fibres (polyimide, PI, multi-lobal, tri-lobal)	260°C	Dimensional stability over 204°C but requires oversizing of filter to maintain proper bag to cage fit. Small pore size of 0.5-1 µm (traditional needle felt scim have a pore size of 15-20 µm).	£££
Pleated elements	Dependant on scim fabric	A/C <3.5:1. Applicable only when additional cloth area is needed to lower A/C ratio and eliminate inlet abrasion.	£££££



# P 84 and high performance fibers for ESP retrofits

- A huge market is developing for substituting filter bags for ESP internals
- The low installation cost vs. a new stand alone baghouse justifies higher bag costs
- Existing precipitators are subject to greater temperature variations and other conditions which can be controlled in a new installation
- P84 and other high performance fibers are being embraced for this retrofit application
- Enel and Eskom are two examples