

IIoT & Remote O&M in the Pharmaceutical Industry

Webinar June 28, 2017



Table of Contents

Markets

The IIoT and Remote O&M forecast

Forecasts for flow and treat components which form the foundation of IIoT

The organization of IIoW (wisdom) to enhance IIoT through Mcilvaine Knowledge Systems

Top 25 Pharmaceutical Companies

A market program can be structured around the top 25 pharma companies

Novartis

The details and program of the worlds largest pharma producer are analyzed

Suppliers

Examples of IIoT initiatives for various suppliers are displayed

This webinar is conducted as part of [N031 Industrial IOT and Remote O&M](#)



Webinar Attendees June 27, 2017

First Name	Last	Company	Email
Steve	Hill	Blender Products	steve.hill@airblender.com
Ketan	Pandit	Crane Chempharma & Energy	kpandit@cranecpe.com
Laura	Crisman	Dewberry	lcrisman@dewberry.com
Gerard	Gach	Lewa-Nikkiso	ggach@lewapt.com
Rita	Rodrigues	Linde	rita.a.rodrigues@linde.com
Antonio	Buendia	Novartis	antonio.buendia@novartis.com
Michael	Kanellos	Osisoft	mkanellos@osisoft.com
Anne	Ryan	Osisoft	anneryan@osisoft.com
Sam	Lakkundi	Osisoft	slakkundi@osisoft.com
Tom	Getz	Samson Controls	tom.getz@samsongroupna.com
Jack	Creamer	Schneider Electric	jack.creamer@schneider-electric.com
Stephan	Eckhardt	SchuF Valve Technology GmbH	stephan.eckhardt@schuf.us
David	O'Dwyer	SchuF Valve Technology GmbH	dodwyer@schuf.ie
Matthew	Caslow	Sensotech	matthew.caslow@sensotech.com
Scott	Affelt	XMPLR Energy LLC	saffelt@xmplrenergy.com
Tom	Fiske	Yokogawa	tom.fiske@us.yokogawa.com



LEWA's membrane pumps technical

Feature	Benefit of LEWA's pumps versus plunger pumps
Aseptic membrane pump head design	Hermetically tight, zero leakage, no chance for penetration of microbes from the outside to the fluid chamber inside
Wear part detection	PTFE sandwich diaphragms with an membrane monitoring system
Drive unit design; compact or variable segment design possible	Drive unit designs allow food grade lubricant oil. No external gears and belt drive required.
Precise, accurate, reproducible	Most precise metering design available with VFD or Servo control
Safety built into the design	Dry run and overload safe (internal pressure relief valves in the hydraulic chamber). Wear part detection.
Low maintenance	Rugged design, low maintenance requirements – wear parts e.g. check valves and membranes with standard life-cycles > 1 year continuous operation.
Low pulsation	3 and 5 head designs provide offset flow resulting in low pulsation and maximum mixing

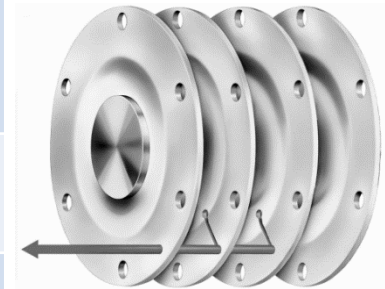
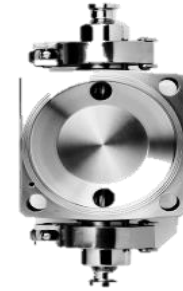

Pharmaceutical IIoT and Remote O&M Market will exceed \$25 billion in 2025

The Pharmaceutical IIoT and Remote O&M revenues will top \$25 billion by 2025. In the accompanying chart the legend is

White - Less than \$25 billion

Blue - More than \$25 billion but less than \$50 billion

Orange - More than \$50 billion

The revenues have been segmented between on site and remote.

As shown on the next page pharma IIoT revenues in NAFTA will exceed \$10 billion in 2025. Western Europe revenues will exceed \$9 billion compared to just \$7 billion in East Asia. However the fastest growth will be in East Asia. Part of this will be due to the booming generics production.

2025 Industrial IoT and Remote O&M Market			
Industry	Onsite	Remote O&M	Total \$ billions
Total			
Chemical			
Electronics			
transportation			
Food			
Metals			
Mining			
Oil and Gas			
Other Industries			
Pharmaceutical			
Power			
Pulp & Paper			
Refinery			
Stone			
Wastewater			
Water			

Pharmaceutical IIoT & Remote O&M Market

\$ billions

World Region	2016	2018	2020	2022	2024	2026	2028	2030
Total	9	12	15	19	24	33	44	56
Africa	0.08	0.11	0.14	0.18	0.22	0.31	0.41	0.52
CIS	0.06	0.07	0.09	0.12	0.15	0.21	0.27	0.35
East Asia	2.03	2.71	3.38	4.28	5.41	7.44	9.92	12.63
Eastern Europe	0.11	0.15	0.19	0.24	0.30	0.41	0.55	0.70
Middle East	0.28	0.37	0.47	0.59	0.75	1.03	1.37	1.74
NAFTA	3.09	4.12	5.16	6.53	8.25	11.34	15.12	19.25
South & Central America	0.41	0.54	0.68	0.86	1.08	1.49	1.98	2.53
West Asia	0.28	0.37	0.47	0.59	0.75	1.03	1.37	1.74
Western Europe	2.66	3.55	4.43	5.61	7.09	9.75	13.00	16.55

Capital Expenditures by Sector

Industry Name	Number of Firms	Capital Expenditures	Net R&D	Net Cap Ex/Sales
Beverage (Alcoholic)	223	\$12,408.58	\$79.95	1.92%
Beverage (Soft)	103	\$8,491.56	\$31.91	3.12%
Building Materials	434	\$13,231.77	\$154.68	3.69%
Chemical (Basic)	774	\$35,195.17	\$694.81	5.18%
Chemical (Diversified)	81	\$25,512.52	\$351.91	5.44%
Chemical (Specialty)	731	\$36,012.80	\$381.58	4.42%
Coal & Related Energy	278	\$15,374.01	\$27.58	0.14%
Drugs (Biotechnology)	884	\$7,545.32	\$5,394.72	17.90%
Drugs (Pharmaceutical)	971	\$37,910.92	\$3,650.69	6.61%
Electrical Equipment	856	\$21,156.09	\$407.28	3.69%
Electronics (Consumer & Office)	153	\$14,081.24	\$5,853.29	4.98%
Electronics (General)	1239	\$48,311.00	\$2,507.88	4.43%
Food Processing	1275	\$54,313.60	\$401.59	3.29%
Healthcare Products	677	\$14,475.92	\$1,787.78	7.44%
Machinery	1270	\$26,205.64	\$1,196.31	3.88%
Metals & Mining	1517	\$67,524.65	\$4.09	2.20%
Oil/Gas (Integrated)	49	\$236,890.69	-\$414.04	2.37%
Oil/Gas (Production and Exploration)	964	\$123,126.88	-\$47.58	-5.47%
Oil/Gas Distribution	210	\$87,457.22	\$1.43	18.86%
Oilfield Svcs/Equip.	544	\$51,177.57	-\$253.10	1.68%
Power	569	\$285,211.90	\$251.63	11.40%
Precious Metals	961	\$28,285.13	\$19.61	4.66%
Rubber& Tires	87	\$7,174.12	\$189.15	2.20%
Semiconductor	535	\$47,146.97	\$4,310.69	16.13%
Semiconductor Equip	258	\$6,285.83	\$585.31	4.87%
Steel	737	\$50,158.03	-\$251.58	2.87%
Utility (General)	57	\$65,799.84	\$322.08	7.13%
Utility (Water)	96	\$7,070.24	-\$1.30	13.71%



McIlvaine Forecasts for Cross Flow Membrane Revenues in the Pharmaceutical Sector - \$millions

World Region	2014	2015	2016	2017	2018	2019	2020	2021
Total	882.90	909.08	937.61	974.67	1,002.48	1,039.08	1,064.92	1,107.33
Africa	8.71	9.08	9.49	10.02	10.42	10.96	11.32	11.88
CIS	5.33	5.52	5.73	5.89	6.22	6.50	6.75	7.11
East Asia	200.84	210.44	221.14	236.30	246.01	260.47	270.20	287.94
Eastern Europe	11.40	11.69	12.01	12.45	12.76	13.19	13.50	13.92
Middle East	26.55	27.77	29.11	29.98	32.20	33.97	35.55	37.87
NAFTA	305.75	313.81	322.14	334.72	340.05	349.47	355.38	364.46
South & Central America	38.63	40.40	42.33	44.36	46.76	49.30	51.27	54.21
West Asia	27.50	29.43	31.55	34.61	36.48	39.33	41.18	44.34
Western Europe	258.18	260.93	264.11	266.34	271.59	275.90	279.77	285.59

Mcilvaine Forecasts for Liquid Cartridge Filters in the Pharmaceutical Sector - \$ millions

World Region	2014	2015	2016	2017	2018	2019	2020	2021
Total	2,091.33	2,157.17	2,229.70	2,308.96	2,395.54	2,490.07	2,490.07	2,596.92
Africa	20.42	21.49	22.65	23.92	25.30	26.80	26.80	28.00
CIS	11.96	12.25	12.57	12.92	13.31	13.74	13.74	14.41
East Asia	486.17	513.17	543.74	577.70	615.47	657.51	657.51	709.23
Eastern Europe	26.95	27.77	28.66	29.61	30.62	31.72	31.72	32.32
Middle East	57.64	59.47	61.47	63.66	66.03	68.61	68.61	72.99
NAFTA	736.12	759.55	783.87	809.18	835.51	862.87	862.87	884.95
South & Central America	88.27	92.46	96.96	101.78	106.96	112.53	112.53	118.13
West Asia	67.18	73.07	79.55	86.68	94.54	103.21	103.21	111.40
Western Europe	596.63	597.95	600.24	603.52	607.79	613.08	613.08	625.49



McIlvaine Pump Forecast for the Pharmaceutical Sector

\$ millions

Subject	2014	2015	2016	2017	2018	2019	2020	2021
Total	642.41	660.91	680.96	702.82	726.41	751.92	779.53	809.46
Centrifugal	321.20	330.45	340.48	351.40	363.20	375.95	389.76	404.72
Diaphragm	94.23	96.94	99.88	103.09	106.55	110.29	114.34	118.73
Reciprocating	77.09	79.31	81.71	84.33	87.16	90.23	93.54	97.13
Rotary	149.90	154.21	158.89	163.99	169.50	175.45	181.89	188.87



McIlvaine On-Off Valve Forecast for the Pharmaceutical Sector - \$ millions

Subject	2014	2015	2016	2017	2018	2019	2020	2021
Total	1,029.46	1,061.67	1,097.36	1,136.55	1,179.43	1,226.33	1,227.60	1,281.37
Ball	315.29	325.22	336.15	348.10	361.16	375.41	375.41	391.52
Butterfly	136.89	141.20	145.95	151.14	156.81	162.99	162.99	169.99
Check	50.58	52.17	53.93	55.84	57.94	60.22	60.22	62.81
Gate	184.01	189.61	195.97	203.12	211.00	219.69	220.96	231.54
Globe	92.91	95.83	99.05	102.57	106.42	110.62	110.62	115.37
Industrial Plug	123.00	126.88	131.14	135.81	140.90	146.46	146.46	152.74
Other	105.26	108.57	112.22	116.21	120.57	125.33	125.33	130.70
Safety Relief	21.52	22.19	22.94	23.75	24.65	25.62	25.62	26.72

McIlvaine Control Valve Forecast for the Pharmaceutical Sector - \$ millions

Subject	2014	2015	2016	2017	2018	2019	2020	2021
Total	383.13	395.19	408.48	423.00	438.86	456.18	456.18	475.75
Ball	16.60	17.12	17.70	18.33	19.01	19.76	19.76	20.61
Butterfly	73.71	76.03	78.59	81.38	84.43	87.77	87.77	91.53
Check	0.00	0.00	0.00	0.00	0.00	0.00	0.00	0.00
Gate	4.51	4.65	4.81	4.98	5.16	5.37	5.37	5.60
Globe	278.73	287.50	297.17	307.73	319.27	331.87	331.87	346.11
Industrial Plug	6.48	6.68	6.91	7.15	7.42	7.71	7.71	8.04
Other	1.97	2.03	2.10	2.17	2.26	2.34	2.34	2.45
Safety Relief	1.14	1.17	1.21	1.26	1.30	1.36	1.36	1.41



McIlvaine Scrubber Knowledge System Analyzing Pharma since 1974

Newsletter or Abstract	Service	Year	Title
Newsletter	Scrubber-Adsorber	1999	Turbo Expander Lowers Temperatures in an Energy-Efficient Manner
Newsletter	Scrubber-Adsorber	1997	AGA Gas Inc.'s CIRRUS CD for VOCs Issue No. 275 Page No. 5
Newsletter	Scrubber-Adsorber	1997	Proposed Rule for HAPs in Pharmaceutical Production Issue No. 277 Page No. 3
Newsletter	Scrubber-Adsorber	1996	Vic Awarded Contract from Pharmaceutical Manufacturer Issue 260 Page 3
Newsletter	Scrubber-Adsorber	1994	Purus Explores Advantages of Carbonaceous Polymeric Resin Adsorbents Issue 246 Page 4
Newsletter	Scrubber-Adsorber	1994	Pharmaceutical Batch Process Poses Air Emission Challenge Issue 246 Page 1
Newsletter	Scrubber-Adsorber	1993	Germfree Filter for Cleanrooms Issue 226 Page 6
Newsletter	Scrubber-Adsorber	1989	Tray Dryer Solvent Emission Controls Compared Issue 184 Page 3
Newsletter	Scrubber-Adsorber	1989	Carbon Adsorption and Incineration for Pharmaceutical Solvents Issue 185 Page 5
Newsletter	Scrubber-Adsorber	1988	Calvert Scrubbers Have Loyal Following Issue 169 Page 5...



McIlvaine Fabric Filter Knowledge System for Pharma since 1974 - Issue 482 in 2015

FABRIC FILTER

NEWSLETTER

December, 2015

No. 482

Camfil's Quad Pulse Package PX Dust Collector Filters Hazardous Dust

The Quad Pulse Package PX dust collector from Camfil Air Pollution Control (APC) is a compact unit for processes that produce hazardous dusts in high concentrations. Pharmaceutical applications include tableting, mixing, blending, granulation, drying, coating, filling and packaging.

The collector has a cleanable filter system that facilitates continuous manufacturing processes and eliminates frequent costly filter replacements. The space-saving unit can be conveniently positioned on the production flow, It is constructed to provide the highest explosion protection in accordance with National Fire Protection Association standards. It can be located indoors with no need for additional explosion safety devices. Indoor installation capability reduces the need for long duct runs and allows easy access for all maintenance functions.

Due to a segmented cleaning process performed during operation, the collector requires a single primary filter cartridge. The high-efficiency primary pleated filter come in a conductive (anti-static) nanofiber or polytetrafluoroethylene media and improves dust release for extended life, energy savings and reduced change-out schedules. It also prolongs the service life of the second-stage filter that provides 99.995 percent efficiency to capture the finest, most harmful dust particles. Using materials from the aerospace industry, the high-efficiency particulate air filter functions as a tested flame and contamination barrier. In addition, the pressure-resistant housing maintains integrity with no damage during an explosion event.

For hazardous dusts requiring full containment to protect workers and prevent cross-contamination, a bag-in/bag-out system is available to ensure safe change at all stages. An integrated fan provides the required suction and is insulated within the unit for quiet operation.



Water Sensing Applications in Pharmaceuticals (water for injection vs pure water) – McIlvaine UPW

Pharmaceutical Applications		
Application	WFI Quality	PW Quality
Bottle Washing	x	x
Compounding		x
Laboratory	x	x
Production	x	x
Rinsing	x	x
Steam Sterilization	x	
Tank Cleaning		x



Sensor Improvements for Ultrapure Water from McIlvaine UPW Market Report

- Ultrapure water products, consumables, and instrumentation are being improved at a relatively rapid rate. Within the instrumentation and control category there are improvements from smart sensors to enterprise management.
- Dissolved oxygen monitoring is one example of the sensor improvement. There are two basic technologies for DO sensing: electrochemical and optical. Electrochemical is the traditional technology and is comprised of polarographic sensors and galvanic sensors. Optical is the latest technology innovation in DO sensing. It is displacing electrochemical technology
- Polarographic sensors operate as an electrochemical cell with a positive electrode (cathode) and a negative electrode (anode) connected by a salt bridge consisting of a saturated electrolyte solution such as potassium chloride (KCl).
- Galvanic sensors operate as an electrochemical battery with a positive electrode (cathode) and a negative electrode (anode) connected by a salt bridge consisting of a saturated electrolyte solution such as potassium hydroxide (KOH)
- Optical DO Sensors reflect a process wherein a dye-impregnated foil or membrane is made to fluoresce when stimulated by a specific wavelength of light such as from an LED, with the fluorescence subsequently "quenched" in terms of intensity and duration by oxygen diffused into the membrane. The degree and rate of quenching is proportional to the concentration of oxygen. The quenching of the fluorescence is recorded by an optical detector and, after suitable algorithmic adjustments made by instrument software, is accurately correlated to the concentration of dissolved oxygen in the water sample.
- Advantages of optical sensors include: no consumption of oxygen; no requirement for flow past the sensor; infrequent calibrations; no electrolyte to replace or anodes to polish; and lower life time cost.



Top 25 Pharma IIoT Purchasers

Pharmaceutical Sales: Branded vs Generics

Figure 1: Global Pharmaceutical Sales (\$ billion)

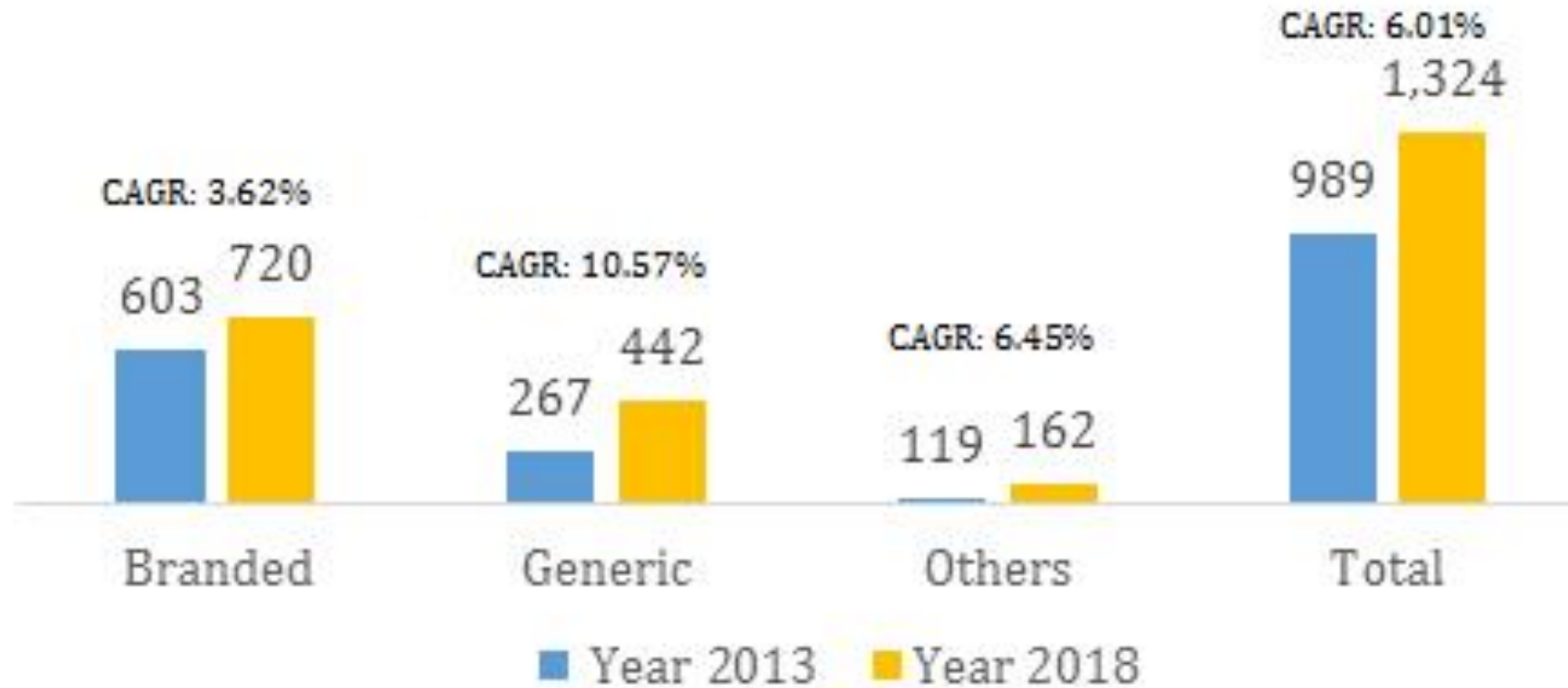

Source: IMS Health

Top Ten Pharmaceutical Companies

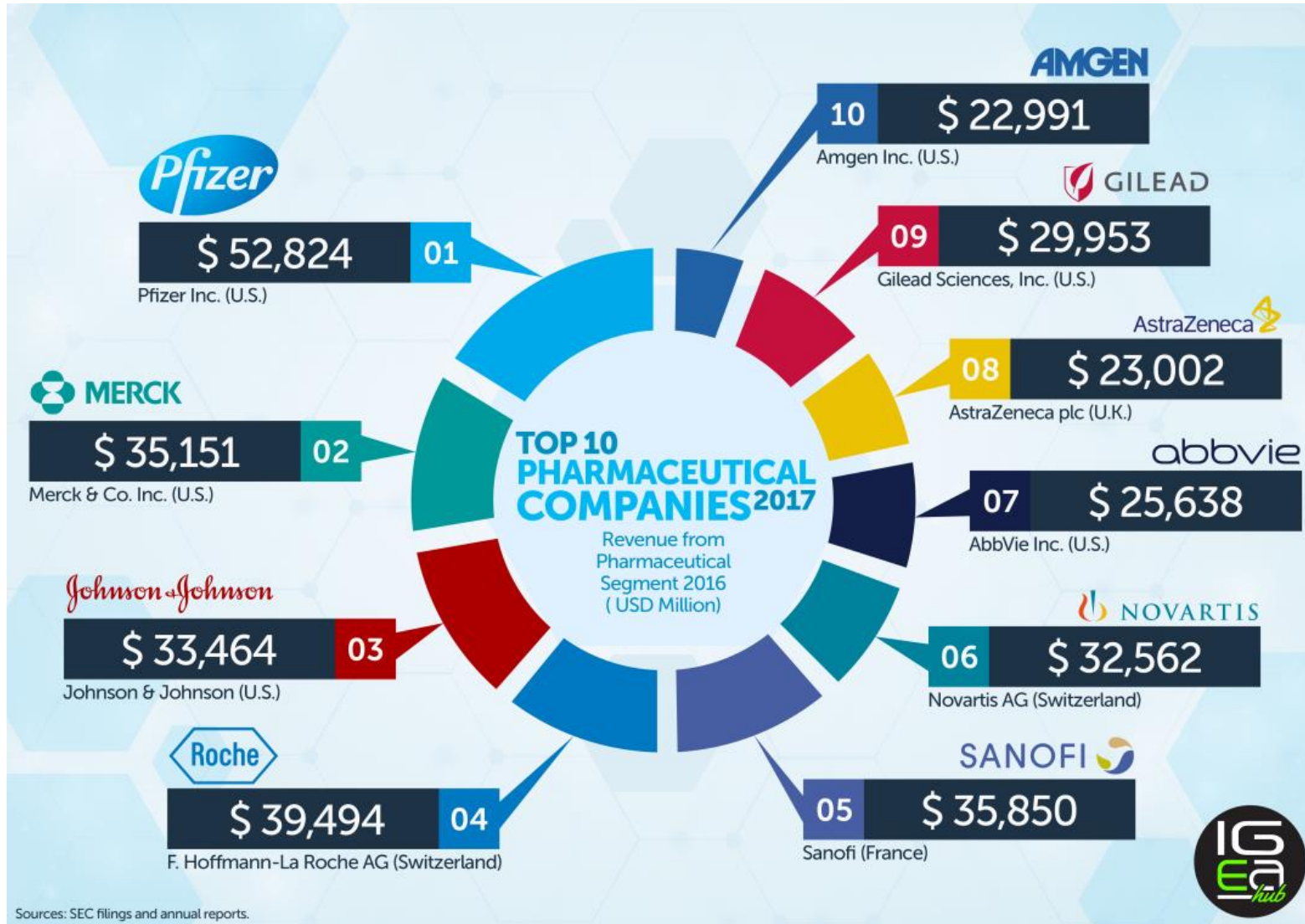

Total Revenues vs Pharmaceutical Revenues

Pfizer derives 100% of its revenues from pharmaceuticals whereas Johnson & Johnson derives only 77%. Novartis is ranked # 6 based on only 67% of its revenues derived from pharmaceuticals. Market share rankings depend on whether generics are included. The top 15 companies account for more than 50% of the pharmaceutical purchases.



Largest Pharmaceutical Plant IIOT and Remote O&M Purchases in 2020

Ranking	Company	2020 IIoT Purchases \$ millions	Market Share %
1	Pfizer	330	4.40
2	Merck	225	3.00
3	Roche	247	3.29
4	Sanofi	224	2.99
5	Johnson & Johnson	209	2.79
6	Novartis	203	2.71
7	AbbVie	160	2.14
8	Gilead	153	2.04
9	AstraZeneca	144	1.92
10	Amgen	143	1.92
11	GlaxoSmithKline	141	1.88
12	Takeda	128	1.70
13	Teva	115	1.53



Largest Pharmaceutical Plant IIOT and Remote O&M Purchases in 2020, cont.

Ranking	Company	2020 IIoT Purchases \$ millions	Market Share %
14	Lilly	108	1.44
15	Bristol-Meyers Squibb	99	1.32
16	Bayer	97	1.29
17	Novo Nordisk	96	1.28
18	Astellas	88	1.17
19	Boehringer Ingerlheim	86	1.15
20	Actavis	81	1.09
21	Otsuka	70	0.94
22	Daichi Sankyo	65	0.87
23	Biogen Idec	58	0.78
24	Baxter	55	0.74
25	Merck KGaA	48	0.64
Total		3373	45.02



Novartis



Novartis is a Large Pharmaceutical Company with Sales of \$32.6 billion

- Novartis was created in 1996 through a merger of Ciba-Geigy and Sandoz. Novartis and its predecessor companies trace roots back more than 250 years, with a rich history of developing innovative products. From beginnings in the production of synthetic fabric dyes, the companies that eventually became Novartis branched out into producing chemicals and ultimately pharmaceuticals.
- The history of Novartis traces the converging destinies of three companies: Geigy, a chemicals and dyes trading company founded in Basel, Switzerland in the middle of the 18th century; Ciba, which began producing dyes in 1859; and Sandoz, a chemical company founded in Basel in 1886.
- In 2016, the Group achieved net sales of \$32.6 billion, while R&D throughout the Group amounted to approximately \$8.0 billion. Novartis Group companies employ approximately 118,000 full-time-equivalent associates. Novartis products are sold in approximately 155 countries around the world.

Novartis Production and R&D Sites

Major Production Sites

- Barbera, Spain
- Barleben, Germany
- Basel, Switzerland
- Fort Worth, Texas, USA
- Grimsby, UK
- Grosswallstadt, Germany
- Holzkirchen, Germany
- Houston, Texas, USA
- Johns Creek, Georgia, USA
- Kundl and Schaftenau, Austria
- Ljubljana, Slovenia
- Puurs, Belgium
- Ringaskiddy, Ireland
- Rudolstadt, Germany
- Stein, Switzerland
- Strykow, Poland
- Wehr, Germany

R&D Centers

- Basel, Switzerland
- Cambridge, Massachusetts, USA
- East Hanover, New Jersey, USA
- Fort Worth, Texas, USA
- Holzkirchen, Germany
- Kundl and Schaftenau, Austria
- Shanghai, China

Novartis Total Water Withdrawal by Source

Conserving water at is a priority, especially in geographical areas where water is scarce, and particularly at our manufacturing facilities where our water use is highest. Novartis monitors water streams into its sites by source and out of its sites by discharge stream, as well as various types of water use at the sites on a quarterly basis. Water volumes are measured at all manufacturing sites and the majority of large administration sites. Water data is estimated at small administration sites based on associate numbers and average assumed consumption per person and per day. Such water balance methodology enables effective water resource and cost management, and helps achieve complete and accurate information on water use

In 2013, a water saving program was initiated at the top 10 sites with respect to water footprint and water scarcity. Eight additional sites were included in the program during 2014. These sites, located in South and Southeast Asia, the United States and Europe, conducted water audits, determined water flows, identified water saving opportunities, set local water saving targets, and implemented relevant water saving projects in 2014 and 2015. The top 10 Novartis sites in water-scarce regions achieved than 20% savings of their total water footprint since 2010

WATER USE (in million m³)

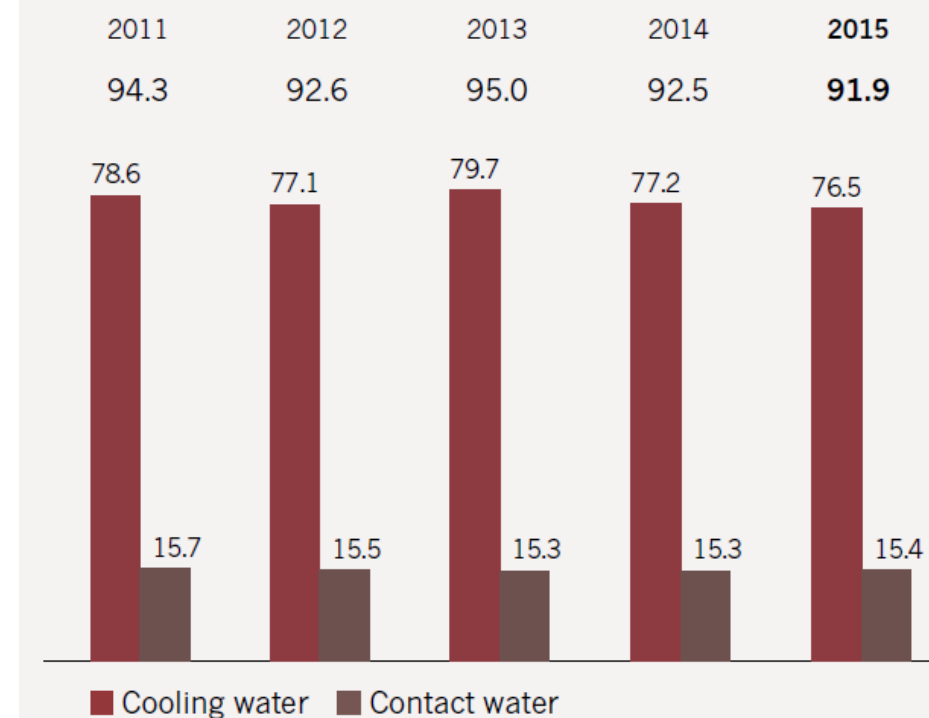

Novartis Air Pollution Control Program

Novartis reports halogenated and non-halogenated volatile organic compounds (VOCs), sulfur dioxide (SO₂) and nitrogen oxide (NO_x) inorganic pollutants and particulates. VOCs mainly originate from the use of halogenated and non-halogenated solvents in various production processes, and are either measured or calculated using mass-balance equations. Inorganic pollutants and particulates arise primarily from the combustion of fuels for steam generation and heating, and are either measured or calculated using standard emission factors from the IEA. Other possible air emissions are not considered relevant. In 2015, emissions of halogenated VOCs decreased to 63 t, from 86 t in 2014. Similarly, non-halogenated VOC emissions were reduced from 635 t in 2014 to 525 t in 2015. Emissions of halogenated VOCs originated predominantly from Sandoz (99.6%).. The Novartis Group emphasizes reductions in VOC emissions in operations worldwide, and has set a target to reduce non-halogenated VOC emissions by 40% and halogenated VOC emissions by 48% below 2008 values by 2016

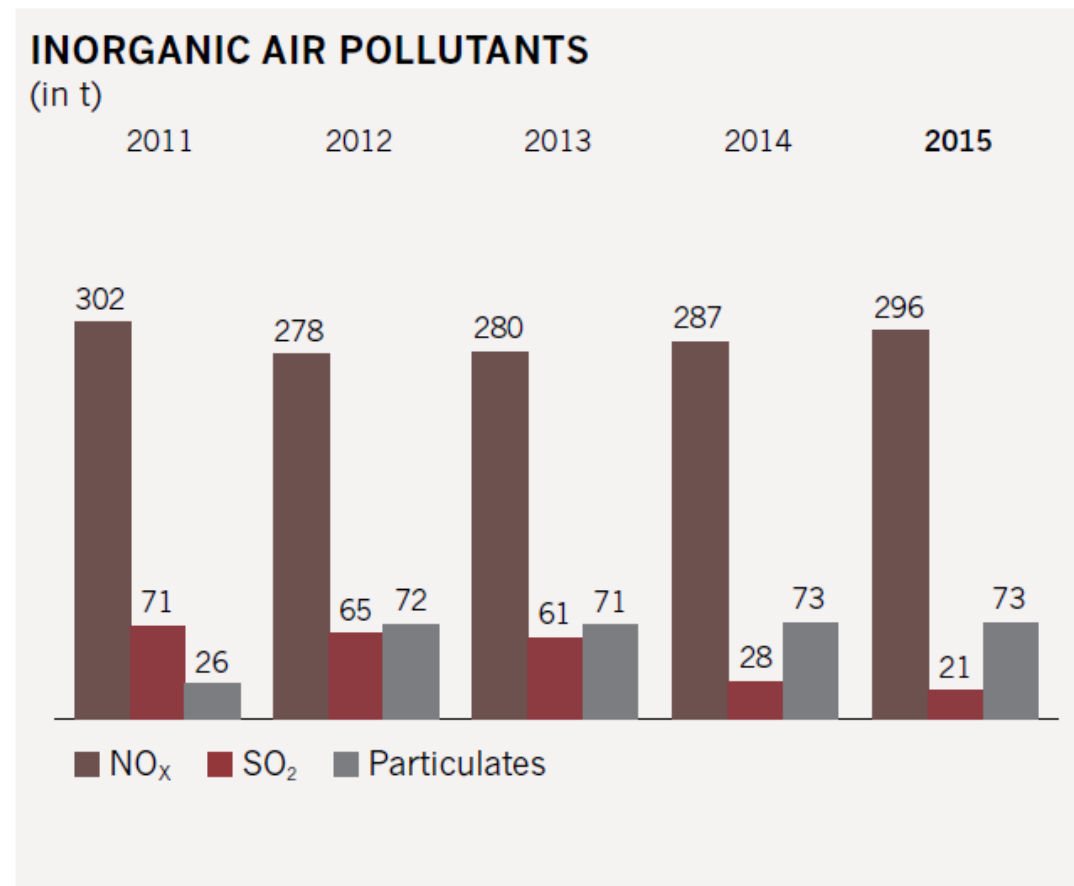

Some of the 64,000 LinkedIn Connections at Novartis

Name	Title	Location	IloW Activity
Rekha Towala,	Mgr. Compliance	Hyderabad India	Enable and drive the design and implementation of an appropriate Compliance Program at Site level across divisions;
Jo Anne (Cifu) Valentino	Executive Director, Quality Operations at Novartis Pharmaceuticals	NYC	Responsible for the leadership of regional quality teams based in USA, Canada, and Latin America with quality oversight of all Novartis Pharma external contractors in the Americas Region.
Daniel Harter	Automation Engineer	Grimbsy UK	Develop and implement control system software solutions within Good Automated Manufacturing Practice (GAMP5) guidelines.
Todd Arnold	Health, Safety & Environmental Officer	NYC	develop a safety culture that empowers employees and provides the tools and resources necessary to prevent work-related injuries and illnesses.
Suresh Kumar BV	Team Lead - Data Analytics at Novartis	Hyderabad India	Was with Rockwell Automation in 2011-12 as global process technical consultant, He was at Camo Software, India for the 5 years previous (<i>for suppliers it is important to know work histories and who might have been with a competitor or your own company</i>)
Antonio Buendia	Head of manufacturing Process Control	Basel Switzerland	Made a presentation which we have excerpted from the OSI 2014 conference. Also he conducts a blog and we have excerpted from it
Joseph Jimenez	CEO (was with Blackstone Group until 2007)	Basel Switzerland	Digital technologies are rapidly transforming daily life --- new levels of mobility and connectivity, and emerging technologies such as artificial intelligence, --, it is clear -----. This “Fourth Industrial Revolution”,



Novartis Toxic Emissions from McIlvaine Air Toxic Emitter Database

- **Facility Address**
- **Facility Name:** NOVARTIS ANIMAL HEALTH US INC
- **Address:** 1447 140TH ST
- **City:** LARCHWOOD **State:** IA
- **County:** LYON **Latitude:** 43.442222 **Longitude:** -96.496667
- **Facility Name:** NOVARTIS ANIMAL HEALTH US INC
- **Address:** 1447 140TH ST
- **City:** LARCHWOOD **State:** IA **Zipcode:** 51241
- **Parent Company:** NOVARTIS FINANCE CO - 966985624
- **Certifying Official:** BILL LATENSER, HEALTH, SAFETY, ENVIRONMENTAL MANAGER
- **Public Contact Name:** BILL LATENSER
- **Primary SIC:** 2836 **Secondary SIC:**
- **Toxic Chemicals:**
- **Chemical Name:** MERCURY COMPOUNDS
Classification: Bioaccumulative & Toxic
- **Facility Address**
- **Facility Name:** NOVARTIS PHARMACEUTICALS CORP
- **Address:** ONE HEALTH PLAZA **City:** EAST HANOVER **State:** NJ
- **County:** MORRIS **Latitude:** 40.806306 **Longitude:** -74.393194
- **Parent Company:** NOVARTIS CORP - 001221845
- **Certifying Official:** JOSEPH J. AFFUSO, EXECUTIVE DIRECTOR, HEALTH, SAFETY & ENVIRONM
- **Public Contact Name:** ROBERT LAVERTY
- **Primary SIC:** 2834 **Secondary SIC:**
- **Toxic Chemicals:**
- **Chemical Name:** NITRATE COMPOUNDS
Stack: **Air Emissions Total Release Pounds:** 328
- **Chemical Name:** METHANOL
Classification: General
- **Fugitive:** **Air Emissions Total Release Pounds:** 17
- **Total Air Emissions:** 17
- **Chemical Name:** TOLUENE
Classification: General Chemical
- **Fugitive:** **Air Emissions Total Release Pounds:** 1
- **Stack:** **Air Emissions Total Release Pounds:** 21
- **Total Air Emissions:** 2



Novartis in McIlvaine Cleanroom Projects

[Novartis](#)

[Novartis](#)

[Novartis](#)

[Novartis / Blueprint Asia](#)

[Novartis / Penn Medicine's University](#)

[Novartis / Sandoz](#)

[Novartis / Sandoz](#)

[Novartis / Subsidiary Sandoz](#)

[Novartis Laboratorio Normal](#)

[Novartis Vaccines](#)

[Novartis-10](#)

[Novartis-11](#)

[Novartis-12](#)

[Novartis-13](#)

[Novartis-14](#)

[Novartis-3](#)

[Novartis-4](#)

[Novartis-5](#)

[Novartis-6](#)

[Novartis-8](#)

[Novartis-9](#)

- **Project Title:** Novartis-14
- **Revision Date:** 1/29/2013
- **Entry Date:** 2/25/2011
- **Startup Date:** 2014
- **Expansion Date:**
- **Location:** Russia **City:** St. Petersburg / Novoorlovskaya Special Economic Zone
- **Novartis Pharmaceutical Manufacturing Plant, St Petersburg, Russian Federation**
- Novartis launched construction of a new pharmaceutical manufacturing facility in St Petersburg, Russia in June 2011. The new facility is being constructed in the Novoorlovskaya Special Economic Zone (SEZ), located to the north of the St. Petersburg city centre. It is expected to start commercial production in 2014.
- The facility produces high-quality generics and innovative pharmaceuticals for Russian patients. The total investment on the project was about \$140m.



McIlvaine Cleanroom Projects, cont.

- **Project Title:** Novartis / Sandoz **Revision Date:** 11/9/2015

-

- **Startup Date:** 2009

- **Expansion Date:** 2015 **Location:** Austria

- **City:** Schaftenuau and Kundl

- **Size:** 242,100 sq. ft. addition

- **Product:** mammalian cultures and microbials, penicillin

- **Address:** Biochemiestrasse 10, A 6250, Kundl, Austria

- **SIC Description:** Biotechnology

- **Description:**

Sandoz has completed a major expansion and is finishing a new 13,000 L. mammalian manufacturing line in Austria and upgrading the 40,000 L. plant in Kundl in order to increase flexibility in operations. **On November 14, 2008, Sandoz opened a new, fully integrated 13 000 L production line for innovative, cell culture derived biopharmaceuticals and antibodies in Schaftenuau, Austria. The new line is an extension to an existing cell culture facility, which has been in operation since 2004. The plant has a highly flexible, modular design and comprises one 100 L line utilized for development and technology transfer, one production line with a capacity of 3 000 L and - now - two independent 13 000 L lines. The fermentation units are operated in fed batch mode and are linked to fully equipped, separated downstream processing lines. All facilities are designed as multipurpose plants, thus enabling maximum flexibility in capacity utilization. The facilities have been designed in close contact with regulatory authorities and meet the latest cGMP requirements. Sandoz Biopharmaceuticals is one of two stand-alone global business units within the Sandoz Group. Sandoz has long been a biotechnological competence center within parent company Novartis, and has decades of experience in the development and production of biopharmaceutical products and active substances. It is also playing a pioneer role in the emerging market for biopharmaceuticals approved by the new biosimilar regulatory pathway.

- **Project Title:** Novartis

-

- **Revision Date:** 1/31/201

- **Expansion Date:** 2018

- **Location:** France **City:** Huningue

- **Product:** biotechnological products **SIC Description:** Biotechnology

- **Description:**

- Already one of the world's largest production facilities for monoclonal antibodies from mammalian cells, the expansion project adds cell culture bioreactors to the site. Novartis selected M+W Zander for qualification services for their Biotechnology Center. The center will manufacture biotechnological products.

- Jacobs Engineering Group Inc. announced it was awarded a contract to expand the Novartis Pharma S.A.S. Biotechnology Center in Huningue, France. Under the terms of the agreement, Jacobs is providing engineering, procurement and construction management (EPCM) services to increase the site's production capacity by 70 percent and create a second line of purification that allows for multiple drugs to be manufactured simultaneously.



Big People Matter more than Big Data

Antonio Buendia of Novartis has likened automation success to race driving. The driver needs an engineering team to modify or adjust the vehicle to best suit the style of the user (driver).

He advises that there are two important questions

1. Who are the users and what are their specific needs
2. What are the capabilities needed to develop and drive the program

Antonio believes that you need people with

- Operations and process experience who will be in direct contact with the user or are the users
- Automaton and equipment knowledge
- IT knowledge

He advises

- Select the right technology
- Assemble a well diverse team
- Design, configure and adapt the tools to the specific needs and style of the user

Organization and capabilities

What resources are needed for driving the change ?

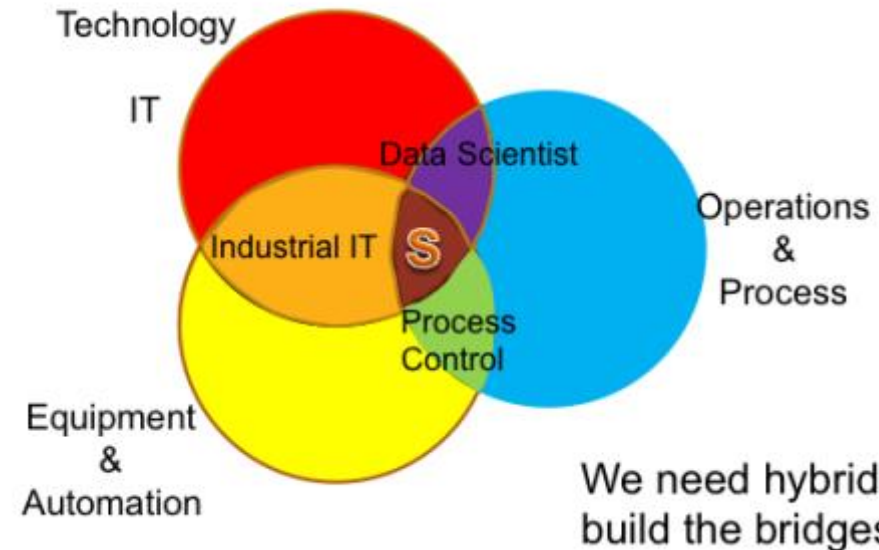

Novartis - OSI Partnership

Our journey with OSIsoft

Long relationship

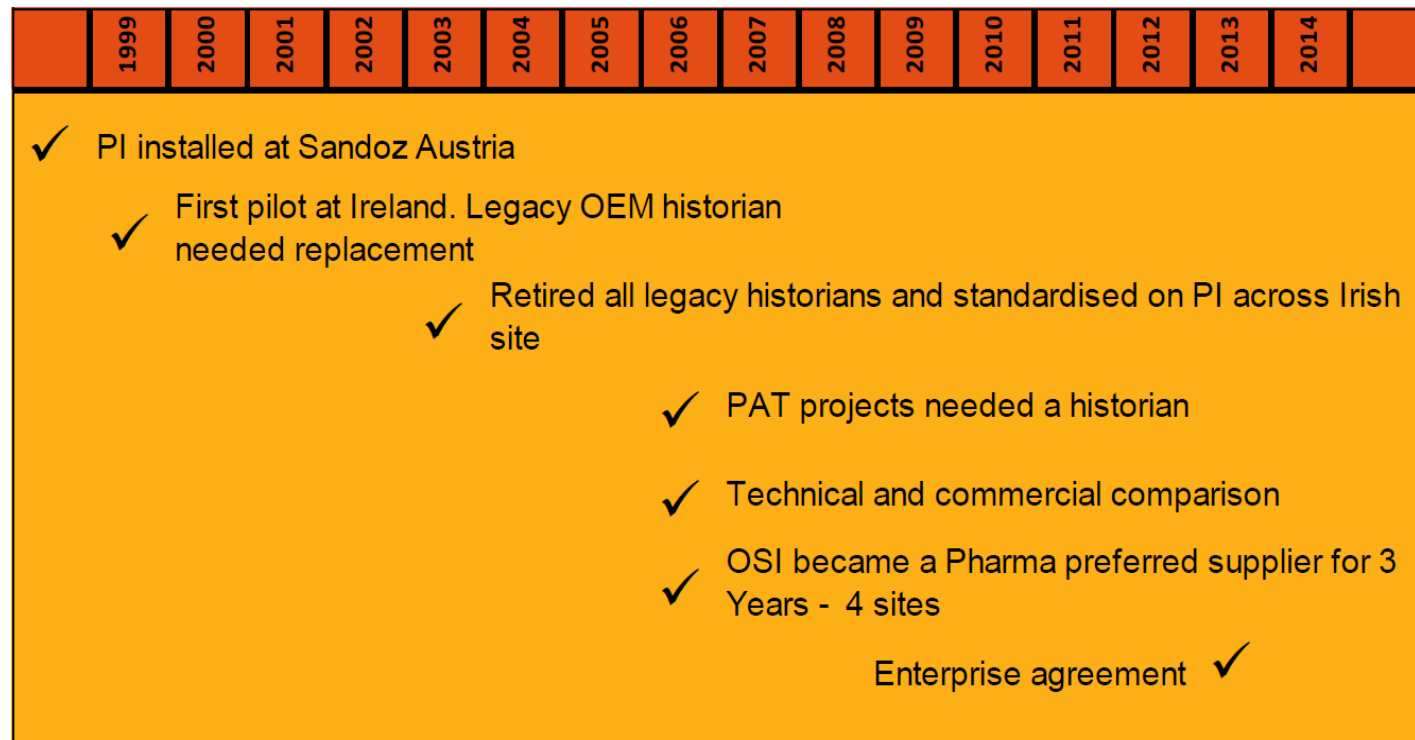

Novartis Analysis of Automation Trends

What is the 21st century automation about ?

Automation strategy

- What is the 21st century automation about ?
- It is not about
 - Robotization ?
 - Uniformity ? Same brands ? Same PLCs ?
 - Vertical integration ?
- It is all about..
 - DATA
 - **The right information, for the right user, at the right time**

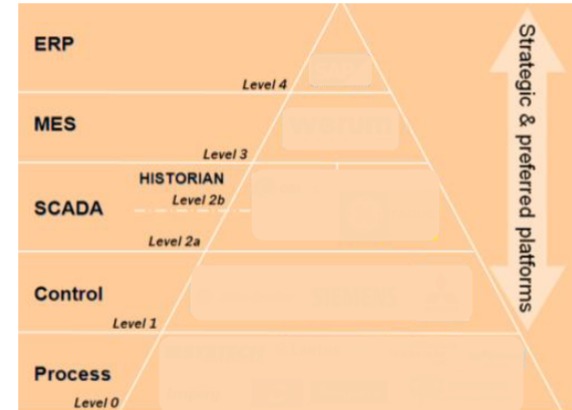

Four Automation Business Drivers for Novartis

The four automation business drivers *Automation strategy*

- Is my process IN control ?
- How can I improve my process ?
- What are the sources of variability ?

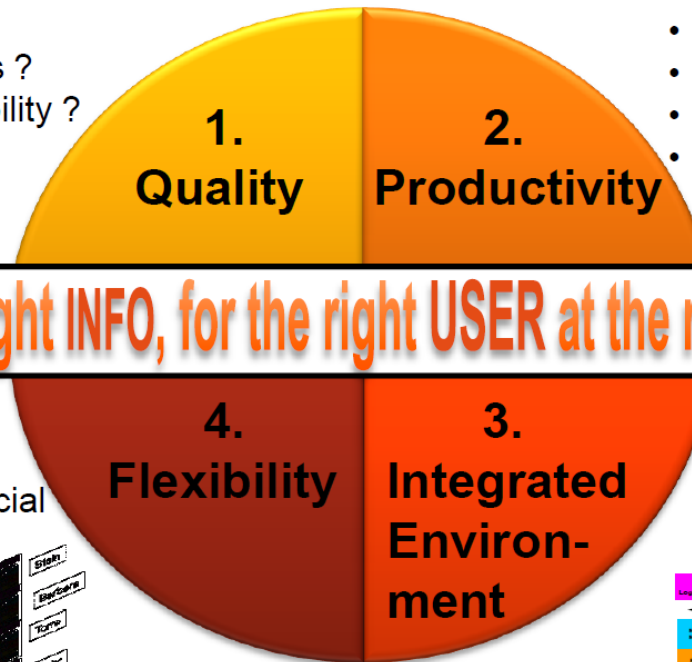
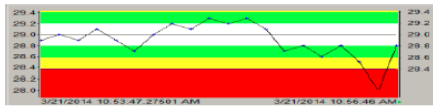

- What is the OEE, how to improve it ?
- What is the yield ?
- Why are machines stopping ?
- Visual management



- Product transfer across sites
- Visibility of supply chain
- Transfer from R&D to commercial

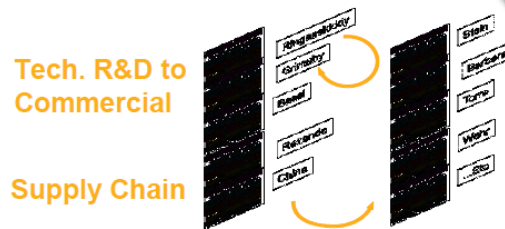

- Systems are integrated
- Data flows from ERP to shop floor
- And viceversa



OSIsoft PI System as the Central DATA Layer

The PI System as the central DATA layer
Simplified interface strategy

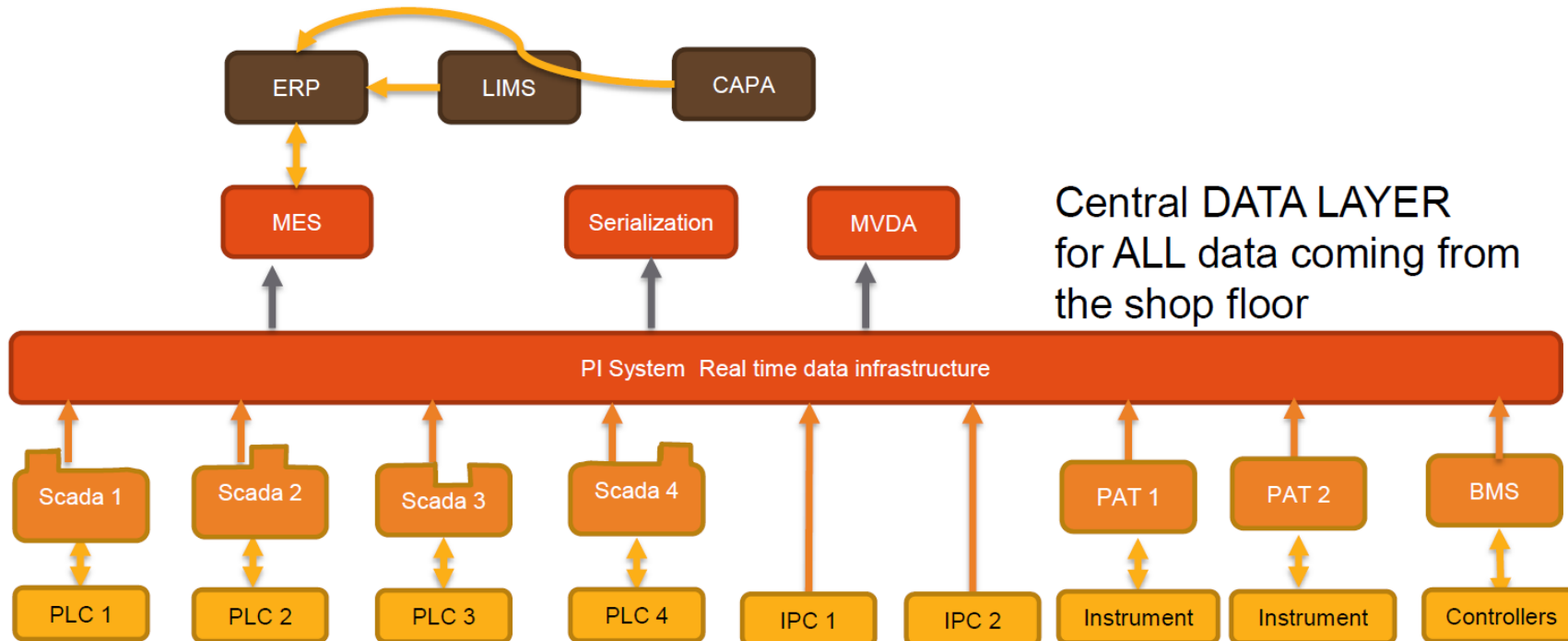

Novartis Critical Success Factors

Manufacturing information process control technology

Our Novartis' critical success factors

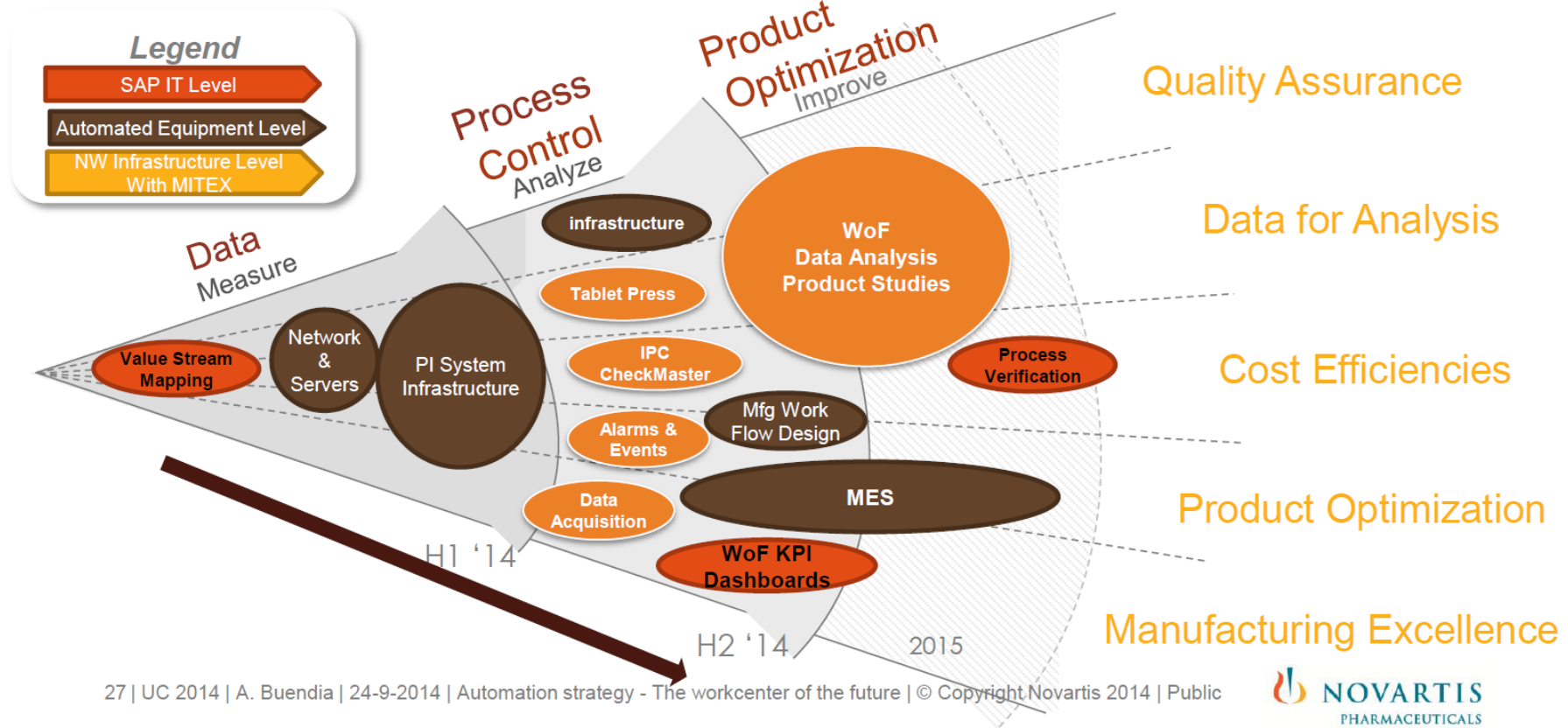

Lights Out Manufacturing

Lights out manufacturing

The goals of the WoF

- High visibility of process without entering the room
- Integrated automated In-process-controls
- Minimum manual intervention increase product quality
- Ideally, the light in the production room can be switched off

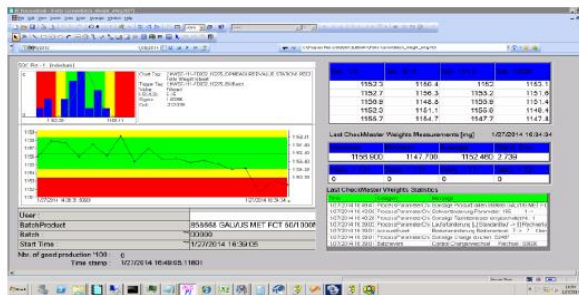

Control charts
Alarms & Events

Manual Activities & Interventions

- Aspect Check
- Lubrication cycle
- Manual IPC for Check master breakdown
- Bin change

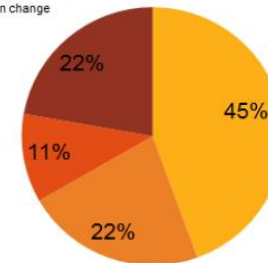

Major Causes of Stoppage

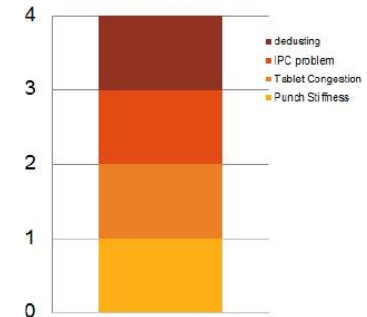

Suppliers

Alkemy Innovation uses a Suite of Available Technologies and Tools to Support Optimal Data Analytics

Reduced staff, relative to a growing pipeline, combined with the need to develop medicines faster to meet patient needs, results in an important drive to gather better data and to automate the process wherever possible.

Innovation is required, and possible, with the right attention paid to specific items, including:

- Sample and data management, upstream and downstream.
- Continuous manufacturing opportunities.
- On-line measurements combined with at-line analysis (and on-line).
- Correlation of product quality to key process variables.
- Model-based, predictive, process control.
- Automation of repeated analysis tasks and reporting for future reference.

To deliver data analytics solutions or new process models, Alkemy Innovation works with a suite of available technologies and tools that support optimal data analytics at several levels:

An Effective Data Strategy:
Everything accessible from just one place...

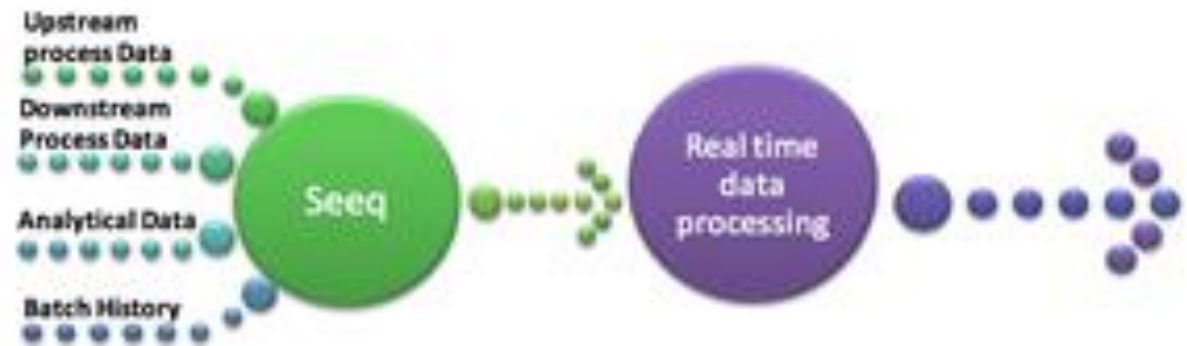

An application for engineers and pharmaceutical scientists to quickly discover insights from industrial process data.

Alkemy Innovation Bioreactor Data Analytics with Multiple Devices

Scale up of a new upstream bioreactor process often happens across a multitude of equipment sizes. With a changing micro-environment, there is potential for a new physical situation to arise, requiring a review of the process conditions needed for successful production of the desired protein. Choosing the right data connectivity, aggregation, and analytics components is critical. Lack of data and insight often leads to additional time-intensive experiments that don't effectively leverage knowledge from the past.

The approach taken to address these issues and enable rapid troubleshooting in this case included:

Define the physical situation to determine the key physics involved.

Identify the key variables and determine all of the data streams both on-line time-series data, such as O_2 flow rates, glucose addition rates, acid or base addition rates, temperatures, and pH, and off-line contextual data, such as integrated viable cell density, titer, and media component concentrations.

Recognize how and where these key data are collected and stored.

Leverage an effective data analysis, visualization, and reporting application alongside lab-scale and pilot-scale experimentation.

Specifically in this case study, the time-series data from a DeltaV historian (Emerson Automation Solutions) was accessed by data analytics software (Seeq). Multiple analytical devices including the Vi-Cell cell counter (Beckman Coulter) provided integrated viable cell density data, and the NovaFlex Bioprofile Flex instrument provided key media data.

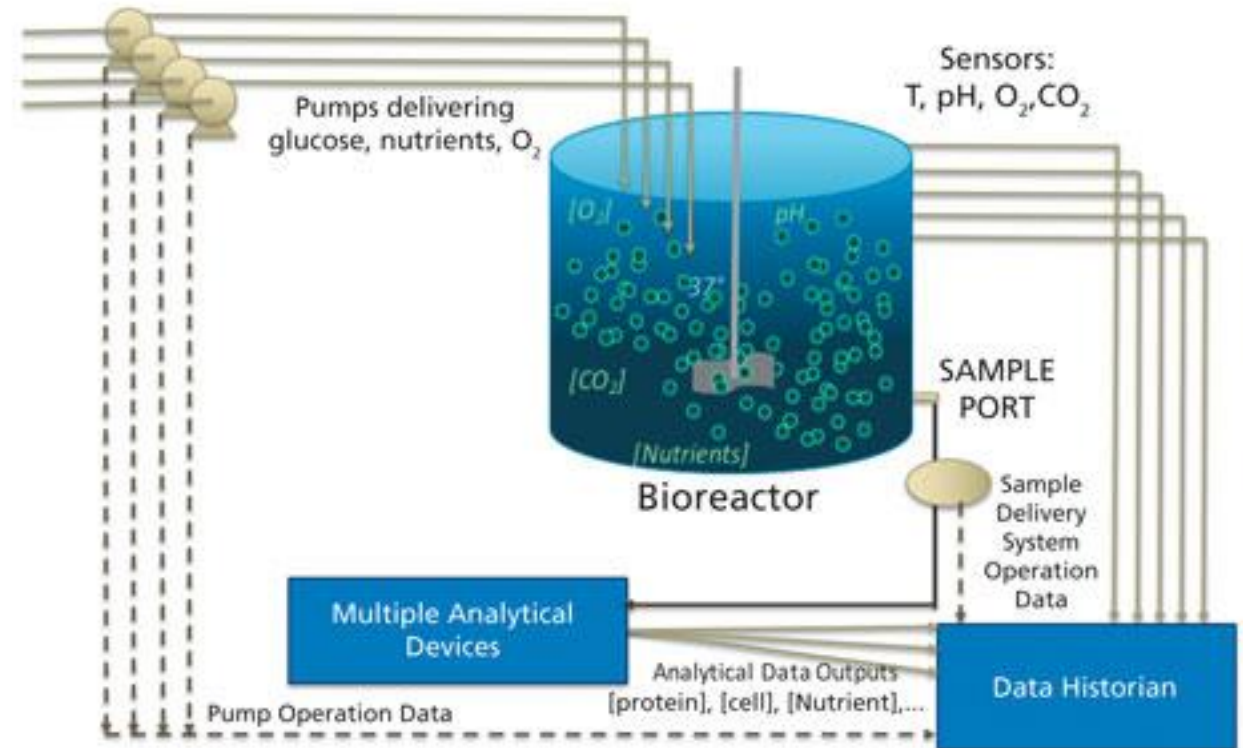

Alfa Laval ThinkTop Controls and Monitors Pneumatic Valves

- The ThinkTop is a control and indication unit used in conjunction with multiple kinds of processing valves. It is used mainly to control and monitor pneumatic valves. Mounted on top of the valve, it receives signals from a PLC to control the valve and sends feedback signals to the PLC to indicate when the valve is in a certain position. The ThinkTop is used to control a pneumatic valve and/or to report the position of the valve remotely through an electronic signal.
- ThinkTop is available with a digital signal, AS-Interface, or DeviceNet network protocol compatibility.
- Alfa Laval's ThinkTop utilizes a magnet mounted on the valve stem and a sensor unit to detect the valve position. The sensor unit contains sensor chips that detect the axial magnetic field of the magnet with an accuracy of ± 0.004 inches. This magnetic system means that the ThinkTop can provide accurate position feedback without any mechanical switches, and without any mechanical adjustments. Valve control is provided by means of optional 1, 2, or 3 pneumatic solenoids installed within the unit.
- The ThinkTop unit is set up through a simple process that utilizes a few switches within the unit.

AVK InterAPP Valves for Bachem AG

- Bachem AG built a new solvent tank depot for both fresh and spent solvents. The tanks in this depot were fitted with ball valves and butterfly valves made by InterApp AG. Solvents are often corrosive and in certain aggregate conditions explosive. The ball valves and butterfly valves were installed specifically for use in the ex-zone (outside: Zone 1 IIB T4 / inside: Zone 0 IIB T4). The gasket materials used on the tanks containing fresh solvents, moreover, had to meet the requirements of the American Food and Drug Administration (FDA).
- This kind of application calls for maximum safety and reliability. Type BVC21 compact ball valves with hand levers and pneumatic actuators were used for the fresh solvent tanks. Bianca LUG-type butterfly valves with 316L disks and a conductive, black fluoro-plastomer liner were used for the larger apertures – from DN50 to DN200. These valves are fitted either with a hand lever or with a pneumatic actuator and in some cases with a feedback unit. The gasket which has contact with the product complies with the FDA requirements. Bianca LUG-type butterfly valves were used for the spent solvent tanks as well, but this time with a black, conductive disk with the same drive units as those used on the fresh solvent tanks. InterApp fulfilled customer needs according to FDA, ATEXconformity and certification.
- *AVK Group includes two valve companies serving the pharma industry. In addition to InterAPP there is World Valve Group who supplies butterfly valves*

Buerkert has Software and Components for Pharama IloT and Remote O&M

- Buerkert has a range of valves, sensors and other components for hygienic processing. It also now has a cloud based monitoring and control system.
- The pneumatic process interface provides the software and valves in modular packages.
- In combination with process valves, Bürkert's analytical sensors and controllers for pH and conductivity measurement address pharmaceutical CIP and SIP applications. Inductive transmitters are employed in the CIP makeup loop whereas the return CIP must be able to measure the very low conductivity of the final rinse water which is commonly WFI quality.

Bürkert Device Cloud Remote Monitoring, Data Acquisition & Worldwide Alarming

- Bürkert's mySITE solution uses the 'Device Cloud,' integrating software, platform, infrastructure and devices 'as a service.' A packaged hardware and software solution, mySITE puts your assets at your fingertips with a simple and cost-effective system that is suitable for any existing set of sensors and networks. The mySITE system offers the ability to see what is happening in your process from anywhere in the world - via any internet web browser, on any computer, mobile phone, tablet or smart phone. The system allows the client to set alarm conditions, which will email, SMS text or web-notify you immediately, so that you can handle it easily and without logging into remotely to SCADA or travelling to site.
- Bürkert has packaged this solution for the process control industry. Within this area, Bürkert Australia has focused on particular applications including:
 - - Water treatment effluent monitoring
 - Remote monitoring of tanks for chemical and petrochemical industries
 - Mining and mineral processing monitoring

Buerkert Pneumatic Process Interface

- The Pneumatic Process Interface is the heart of Bürkert's pharmaceutical expertise. With clients around the world at pharmaceutical plants, builders of fermenters, filtration skids and WFI production equipment Burkert meets the needs for modularity, performance and ease of use. The scope includes the hazardous location which is often present in pharmaceutical and cosmetic production plants with systems built for Zone 1 and 2 or Class 1 Div 1 FM as required.
- AirLINE consists of a gateway or mini-PLC, modular I/O slices and rugged pneumatic valves on one address. The gateways connect with all of the normal bus systems and TCP/IP networks for ultimate flexibility in your design.
- Mini-PLCs can be incorporated easily into the island and in many instances can be programmed for your application by Bürkert engineers. The I/O slices allow 4-20 mA inputs, high frequency counters, thermocouple inputs, relays, RTDs and AS-I bus controllers.

COPA-DATA UK: Pharma should be Moving to Open Automation Software

For IoT to succeed in pharmaceutical manufacturing, industrial equipment from a variety of manufacturers must be able to connect to high level automation systems or devices that can access back-end databases or cloud services. Usually, this is achieved through connected control devices, such as PLCs. Despite the adoption of automation in recent years, there are still many legacy systems in operation that fall short and even some original equipment manufacturers (OEMs) that do not support open standards in their products and solutions.

For example, some existing systems may only communicate locally, without networking or over non-supportable communications protocols. In some cases, the visualization of machines has been developed in propriety software locked by the developer.

Without replacing propriety applications with open and independent automation software, like COPA-DATA's zenon, which is independent of any equipment manufacturer, the machines and HMIs will require reengineering. To fix this incompatibility, manufacturers should expect increased costs for reengineering of systems integration. By using open automation software compatible with a wide range of communication protocols, pharmaceutical manufacturers can ensure the transition to the Industrial IoT is as seamless as possible.

Another reoccurring problem comes in the form of Big Data. For IoT enabled facilities, the ever increasing amount of data can be a real dilemma. While an increase in accuracy and more detailed production data is, without doubt, a benefit for organizations, the abundance of information means manufacturers require a re-think of data storage, archiving and analytics. In these instances, the obvious solution would be to migrate to off-site storage or cloud computing. That being said, there remains some anxiety amongst pharmaceutical and medical manufacturers, with regards to the idea of storing production data outside the factory walls.

Without doubt, data collected from industrial equipment is sensitive and therefore should be protected from unauthorized access.

Companies can keep critical information on premise and push raw data to a cloud storage solution, the data only holds value when the two parts are combined. This hybrid solution meets both needs, making an organization less vulnerable to cyber-attacks, whilst maintaining connectivity. With so many options for storing industrial data, it is no surprise that security within Industrial IoT will be a huge topic of discussion in the years ahead.

*Comments by **managing director of industrial automation software company** [COPA-DATA UK](#),*

Danaher Pall provides Single Use Systems with Automation

- The use of automation in running complex single use systems provides benefits in manufacture, such as consistency in product quality, reduced labor costs and reduction of operator errors.

Pall offers a well considered approach to the design of automated systems for single-use processing, to facilitate their use and adoption. This requires focus on all aspects of the system - hardware, consumables and the control system - ensuring ease of use for the end user.

This approach to good system design, provides the market with technologies to improve flexibility of manufacturing facilities, and to improve efficiencies and costs in upstream and downstream processing

- The Allegro single-use platform provides a comprehensive range of disposable process solutions from upstream, through downstream to formulation and filling. Pall has developed a unique approach, keeping the same materials of construction to allow easy scale-up from lab scale to full cGMP commercial operation, with the capability to provide the same robustness, reliability and batch records that are required to produce drugs. Pall can serve our customers globally with strong technical support and a very robust and reliable supply chain with a global manufacturing platform meeting all the necessary quality requirements.
- Applications include: sterile filtration, bioburden reduction, depth filtration, virus filtration/inactivation, media & buffer preparation, membrane chromatography, pH adjustment and final formulation & filling. A manifold selection tool facilitates selection of sensors, connectors, tubing type, filters and pre-filters needed for each application. Intuitive, easy to read labels on the manifolds sets ensure easy, error free installation. The fully automated MVP system provides reliable control of process conditions and monitoring of all process variables, and the use of automated valves in the system allows more complex process steps to be simplified into an automated sequence.

Danaher - Hach TOC Analyzers for Trihalomethane Excursions

- With thousands of units installed worldwide in pharmaceutical manufacturing plants, Hach Ultra's ANATEL Total Organic Carbon (TOC) analyzers have become the industry standard for monitoring Purified Water (PW) and Water for Injection (WFI) systems. ANATEL TOC analyzers are designed specifically for use in PW and WFI applications where accuracy and stability are critical parameters for daily process monitoring of water distribution systems. The need for accuracy and stability drove Hach Ultra's decision to use direct conductometric (DC) technology, self-calibrating conductivity circuits, and dynamic endpoint detection to measure on-line TOC.
- ANATEL TOC analyzer measures trihalomethane (THM) excursions in an UPW system. The unique sensitivity of DC analyzers to the halogen ions created during oxidation of THMs can alert UPW engineers to potential excursions that might harm the water system components or even violate the EPA's requirements for total THMs in water used to manufacture pharmaceutical products. When incoming source water or UPW meets EPA requirements for THM levels, ANATEL TOC analyzers will never report a false positive TOC value. In the rare occurrence of THM excursions, the ANATEL analyzer becomes more than just a TOC analyzer – it also becomes a THM event monitor.

Danaher Chemtreat has a Wide Range of Chemicals for Pharma Water and Wastewater as well as Air Treatment

- In addition to standard water management programs, ChemTreat offers a variety of specialty products and services unique to the industry, and specific to each pharmaceutical wastewater treatment facility's requirements. Some of these products include: calcium chloride brine system inhibitors, reverse osmosis system antiscalants and cleaners, environmentally-friendly biocides for high-purity air scrubbers, cleanrooms and other critical air systems in pharmaceutical manufacturing plants, and research and development sites.
- With Pall single use systems, cartridges, and cross flow membrane systems along with Hach sensors for chemical measurement Danhaer is well positioned to move forward with pharmaceutical IIoT and Remote Monitoring

Danaher Chemtreat Monitoring and Control

ChemTreat's complete line of water technology and monitoring systems allows customers to have complete access for analyzing and managing their water treatment system with ease and efficiency..

The first piece of ChemTreat Solutions® is the controller that collects data from up to 100 sensors including conductivity, pH, ORP, corrosion, chlorine, and many other parameters. This data is then analyzed to determine if any water quality parameters are out of specification. Depending on pre-set parameters and user settings, operators can rely on ChemTreat Solutions® water monitors to automatically adjust chemical feed rates to ensure proper dosage. Operators and field engineers also have the ability to input their samples into the system to validate the results. Users can then access their data either directly from the control panel or from a wide range of easy-to-access reports, allowing your staff to keep sensitive information in-house. If you'd like increased visibility into your water treatment system, operators can install our CTVista+® open platform, web-based application. This software allows users to access information from their ChemTreat Solutions® controller from virtually anywhere. Users can view reports, system history, inventory levels, alarms and notifications, and system trends from a tablet, smart phone, PC, or control room, 24/7.



Simplifying Monitoring of Chromatography, Fermentation, Phase Separation and Filtration with E+H Multi Channel Analyzer

Endress+Hauser offers the Liquiline CM44P multichannel analyzer transmitter that accepts up to 16 parameters from analytical sensors and transmits them via 4-20mA HART, Profibus, Modbus or EtherNet/IP. The CM44P accepts inputs from up to two process photometers and four analytical sensors simultaneously. Sensor types include pH, ORP, conductivity, oxygen, nitrate, turbidity, free chlorine and ion selective sensors.

Benefits

- Intelligent design: One controller for all parameters including process photometers
- Cost-saving and comfortable set-up of measuring points: Combine up to two process photometers and four Memosens sensors for a perfect fit to your application
- Easy to operate and calibrate thanks to intuitive user interface and menu guidance
- Seamless integration into distributed control systems thanks to digital fieldbus protocols such as Modbus, PROFIBUS and EtherNet/IP
- Process control and safety: Integrated web server that allows the operator to remotely view diagnostic data, perform configurations, or access device parameters in any web browser - even via Smartphone
- Available as DIN-rail version for applications with limited mounting space - perfect for system integrators and skids

Multiparameter Monitoring

- Chromatography, fermentation, filtration and phase separation require monitoring of multiple parameters. In chromatography, for example, the combination of a UV process photometer and pH, temperature and conductivity sensor inputs ensures accurate detection of the target product. It also verifies buffer quality in the column is correct, leading to optimum product yield. The CM44P detects the transition from product to cleaning phase, allowing optimization of cleaning and flushing cycles.

Standardized digital platform

- The CM44P interfaces to all Memosens sensors from Endress+Hauser and other vendors. Memosens is an international standard, with all sensor-related data stored directly in the sensor head. The CM44P can access this data for analysis, mathematical calculations and diagnostic purposes, and transmit it via various interfaces.



Emerson Valves in Pharma Applications

- Protecting vital equipment and material from the risks caused by pressure changes and fire is a fundamental requirement for many industries. These Emerson products help protect a broad range of applications, including oil & gas, tank protection, flame protection and pressure relief.
- BIRKETT, BAILEY, MARSTON and MARVAC low pressure tank protection valves provide effective pressure control and steam relief in variety of applications in the pharmaceutical industry. AMAL Flame arresters offer reliable protection against fire propagations and explosions.
- Many ingredients used in the chemical processes of the pharmaceutical industry are highly flammable and have the potential to generate a dangerous dust cloud atmosphere that can easily ignite with a single spark.
- BIRKETT and BAILEY provide a wide range of reliable pressure reducing safety relief valves to protect against overpressure in hazardous environments. MARVAC's comprehensive range of low pressure tank protection valves will ensure toxic and harmful substances are stored safely and securely. AMAL Flame arresters protect pipes, vessels and storage tanks against the accidental ignition of flammable gases and vapours

Pharma Company benefits from Emerson Wireless

- A pharmaceutical company needed to install a pilot plant was in a room with no accommodations for new instrumentation wiring. To install conventional wired instruments, they would have to run conduit and pull wire, which would require excessive cost and time. To alleviate these issues, they decided to try wireless.
- The company purchased and installed one Rosemount wireless hygienic point level switch and one wireless temperature transmitter at each of the six vessels, along with a single wireless gateway for connection to the twelve instruments.
- The wireless transmitters send data over a WirelessHART mesh network to the gateway, which interfaces with the control system via a hardwired Ethernet connection. Because the control system includes native support for both wired HART and WirelessHART protocols, mapping information from the instruments to the control system's data registers was straightforward, essentially a plug and play operation.
- The wireless instruments, network, and gateway worked flawlessly from the beginning and continue to do so, allowing the CMO to provide real-time control and monitoring of the reactor vessel batch processes.
- Building on the success of the first project, Emerson and the CMO are now in the process of installing wireless instrumentation for an elevator system. Materials on the elevator must be maintained at a constant temperature for 1.8 minutes as the elevator moves up and down. The system will have 30 wireless temperature transmitters connected via WirelessHART to the control system.



Emerson Fisher Control Valves at Indena Anti-Cancer Compound Plant Automation, Italy

Top of Reactor Vessel



Remote Control Panel



Fisher Control Valves at the Indena plant. The valves are fitted with FIELDVUE digital valve controllers.

Digital technology is the communication of choice for new plants and plant upgrades. Fisher can provide state of the art Foundation Fieldbus equipment or HART digital protocol. Analog devices are also available for all valves. The digital devices provide reduced commissioning time with greater reliability when your facility is running. Performance can be monitored and upgraded on line.



Evoqua Supplies Solution to Healthcare Manufacturer

- A large healthcare products manufacturer in the United States needed to improve its environmental impact while substantially reducing excessive costs associated with municipal discharge and the operation of cooling towers. A new **waste treatment RO system** was engineered, built and installed in the facility to achieve these goals. Since it was located outside the GMP boundaries, validation (or revalidation) was not necessary. Additionally, to address the unnecessary continuous recirculation, Evoqua designed a system that operated only when needed, and would be shut down/by-passed when not needed by detecting when the waste stream quality was adequate for cooling tower feed. This helped to further increase the efficiency of the waste treatment solution. The system achieved the following:
- Reduced the existing waste stream from 64 GPM to 42 GPM continuously
- Reduced waste produced and feed water required for product production to lower costs, increase efficiency and raise the level of environmental stewardship
- Filters 42 GPM of the waste stream sent to the cooling tower array
- Improve the water quality to the cooling towers to reduce blow-down and potentially reduce chemical costs associated with cooling tower operation

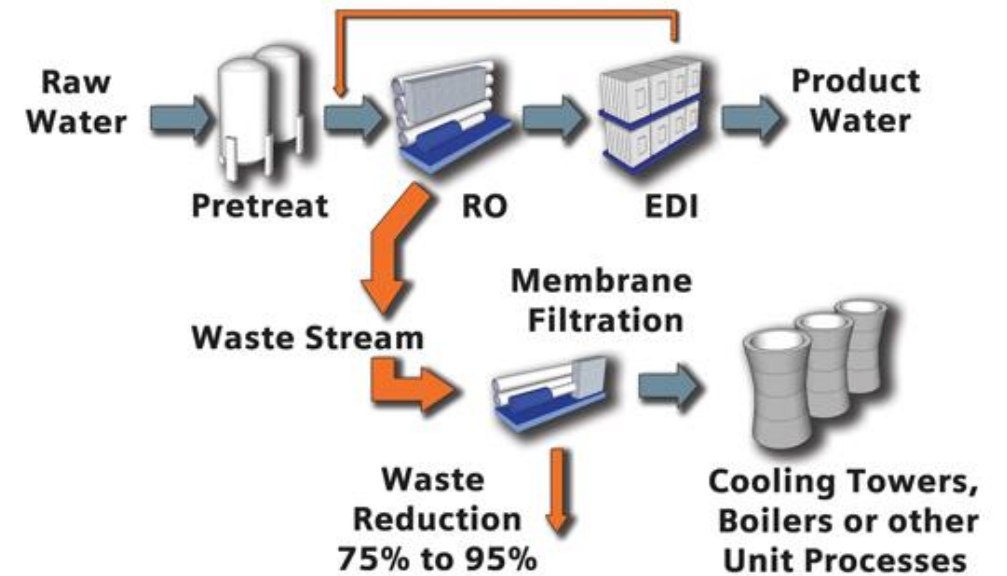

ITT Partnering with Pharma Companies to Improve Valve Maintenance

- Many of the forward-thinking pharmaceutical companies are now partnering with valve manufacturers to assess maintenance frequencies. With proper application data, including temperature, pressure, process fluid data, and exposure times, valve manufacturers can help develop a maintenance program that aligns with the risk profile of the end user. In this way, the end user can save unnecessary maintenance costs and production down time, ultimately reducing their total cost of ownership of the process system.
- Improved valve designs: In recent years, the design of the hygienic diaphragm valve has been optimized to increase productivity, ultimately advancing maintenance practices in biopharmaceutical facilities. New valve technology, for example, can reduce average diaphragm replacement time from 23 minutes to three minutes and total maintenance time from hundreds of man hours to just a few hours, hence reducing maintenance cost by more than 90% (2). Preventative maintenance practices and more innovative technology, such as valves that do not require tools or retorquing, are preventing the potential of human error and making processes safer and more efficient. Improved designs can help meet the biopharmaceutical industry's growing demand for increased productivity, extended maintenance intervals, and reduced operating costs, in conjunction with an effective preventative maintenance program.
- **References** Paul McClune is global product manager, ITT Engineered Valves, www.engvalves.com.



ITT Diaphragm Valves

The biopharmaceutical industry relies on hygienic diaphragm valves for its demanding process applications due to a unique need for cleaning and draining and for pressure and temperature capabilities. Over the past 40 years, the basic design of such valves has remained the same: body, diaphragm, topworks, and four fasteners (see Figure 1). Properly installing and maintaining these valves requires experienced personnel and stringent maintenance practices to assure consistent and reliable valve performance.

Facilities can cut costs and decrease downtime through preventative maintenance, which involves a schedule and process for maintaining equipment; preventative maintenance is particularly important when it comes to valves. Although it can take hundreds of hours a year to properly maintain hygienic diaphragm valves, resulting in thousands of dollars of maintenance cost and lost hours of production, the primary function of a maintenance program is maximized production up-time, reduced planned and unplanned man-hours of labor, and early detection of diaphragm failure

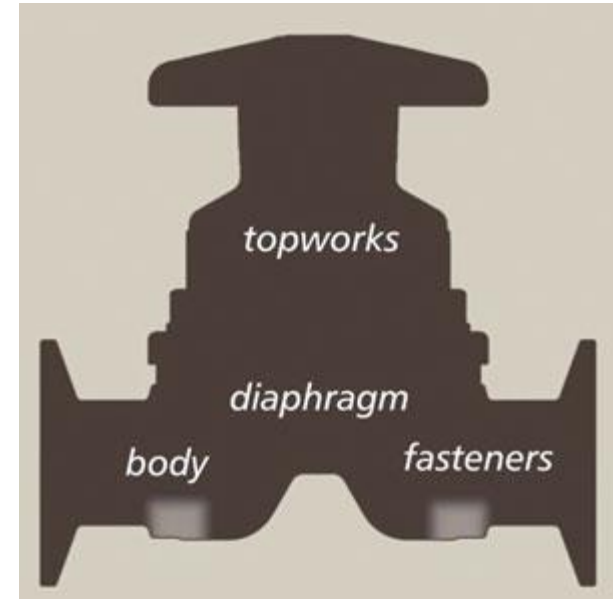

Figure 1 Valve Design –
article in Pharm. Tech by

LEWA Diaphragm Pumps (EHEDG approved)

In the LEWA hygienic pump the sandwich safety PTFE-diaphragm is moved by a pressure transducing hydraulic liquid.

The inlet and outlet valves are provided with ball-valves.

The diaphragm is clamped in such a way that it does not create crevices

LEWA low pressure design < 20 bar

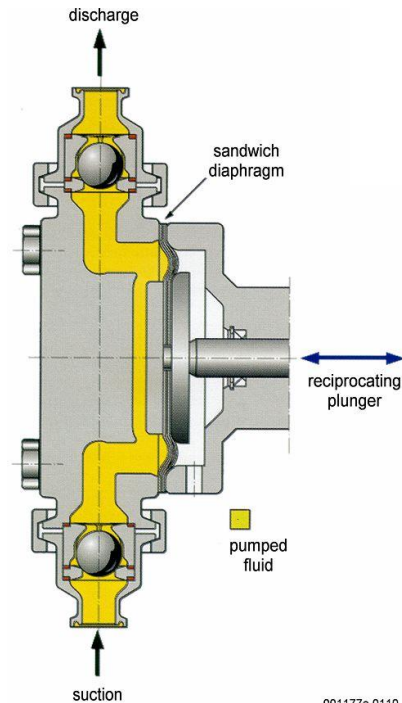

LEWA high pressure design < 450 bar

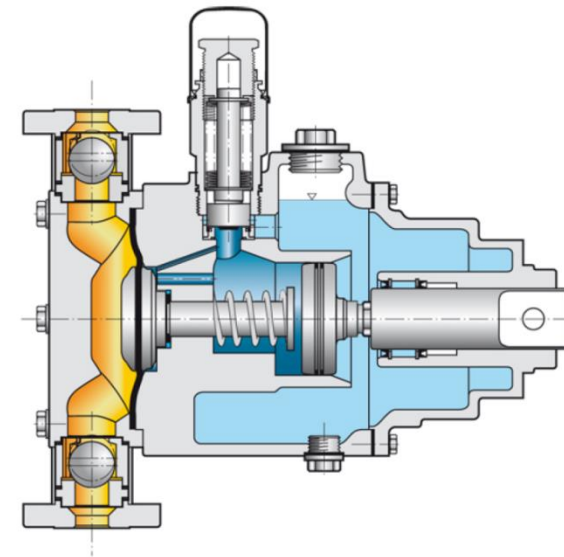

Hygienic pump head design

PTFE double diaphragm

-20 - + 150 °C (SIP possible) up to 100.000 mPas

Over 14,000 LEWA pumps on chromatography systems since the 1980's

LEWA HYGIENIC DESIGNS - Maximum Cleanability

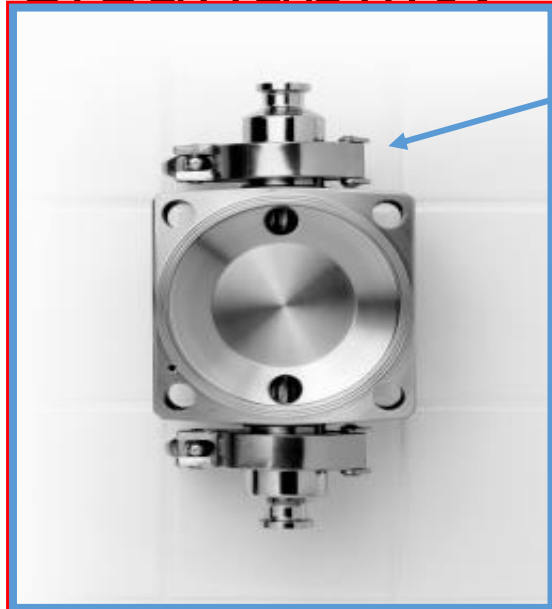

Smooth internals and low hold-up volume

Valve assembly with sanitary connections

Polished wetted surfaces



Hygienic valve designs: streamlined, crevice-free, and CIP-able

4-layer PTFE membrane.
Leak detection monitor
between 1st and 2nd layer

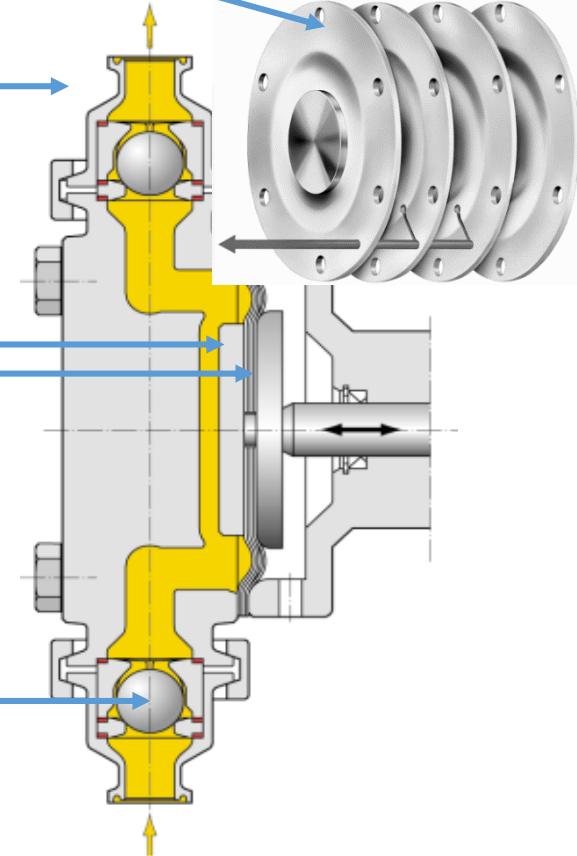

Open product flow-through path

LEWA's membrane pumps technical

Feature	Benefit of LEWA's pumps versus plunger pumps
Aseptic membrane pump head design	Hermetically tight, zero leakage, no chance for penetration of microbes from the outside to the fluid chamber inside
Wear part detection	PTFE sandwich diaphragms with an membrane monitoring system
Drive unit design; compact or variable segment design possible	Drive unit designs allow food grade lubricant oil. No external gears and belt drive required.
Precise, accurate, reproducible	Most precise metering design available with VFD or Servo control
Safety built into the design	Dry run and overload safe (internal pressure relief valves in the hydraulic chamber). Wear part detection.
Low maintenance	Rugged design, low maintenance requirements – wear parts e.g. check valves and membranes with standard life-cycles > 1 year continuous operation.
Low pulsation	3 and 5 head designs provide offset flow resulting in low pulsation and maximum mixing

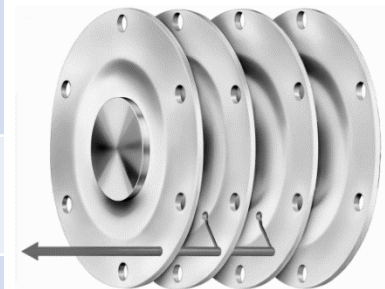
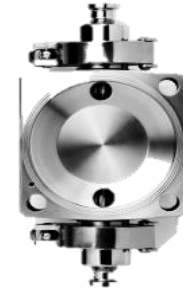

Examples of LEWA bio/pharm systems

EcoPrime HPLC



EcoPrime LPLC



Cell rupture / homogenization pump / system

- 2 triplex-pumps in parallel service
- Special design for 1000 bar
- CIP/SIP
- Reduction of Pulsation by using
- 6 pumpheads
- Stand-by, production possible with 3 heads (compact Triplex-configuration)
- Applications: HP-homogenization
Pharma, cosmetic, cell-rupture, etc.

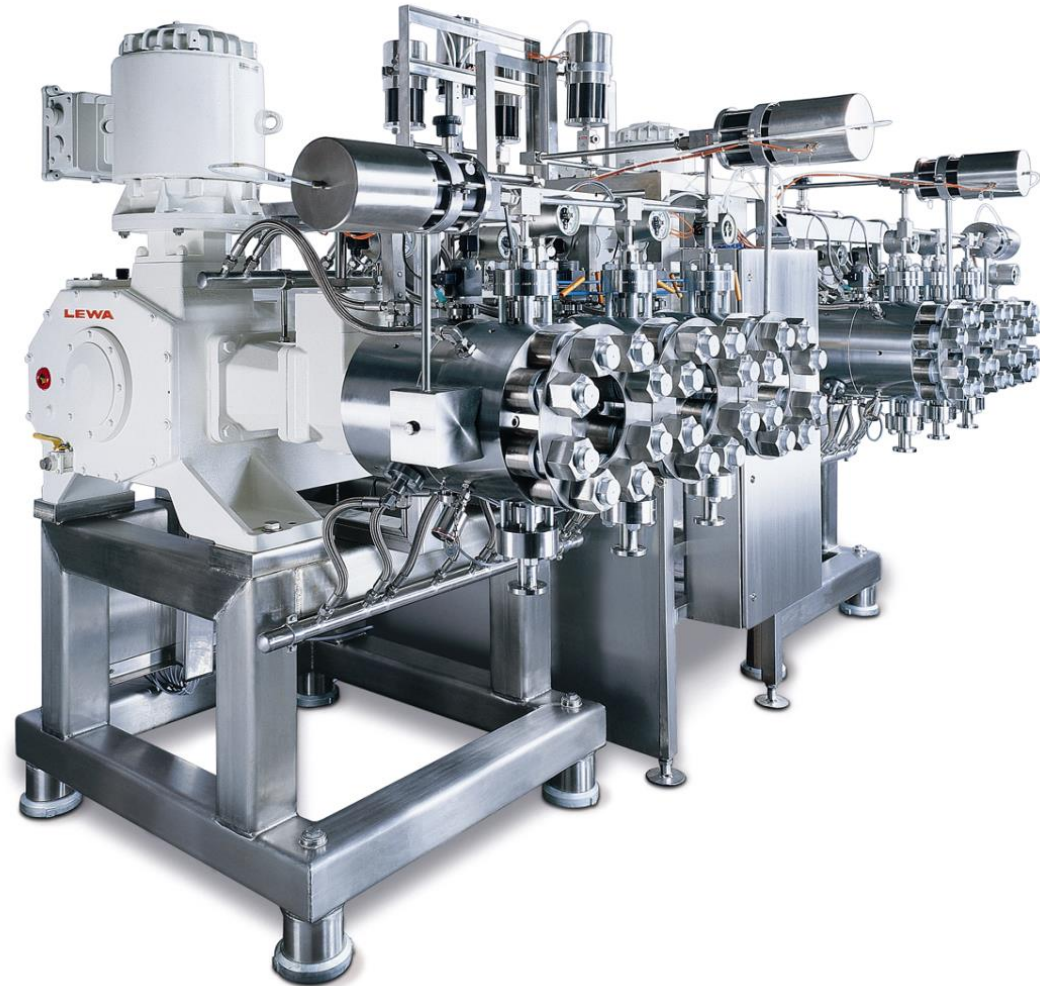

Lewa Diaphragm Pumps Designed for Lowest Total Cost of Ownership

Lewa GmbH diaphragm metering pump has been designed to provide lowest total cost of ownership. The four available sizes cover flow rates of up to 300 l/h and can operate under operating pressures of up to 80 bar. Three-phase motors or AC motors are used as drives in accordance with IEC or the American NEMA standard. The M900 pump head is suitable for virtually any type of chemical and is hermetically sealed. It features a hydraulic-operated, freely oscillating sandwich diaphragm made from pure PTFE.

Due to this special pump head design, LEWA ecosmart is also suitable for contaminated fluids or suspensions. The diaphragm protection system reliably protects the pump from misuse or impermissible operating conditions. An individually adjustable pressure relief valve in the hydraulic part moreover protects the pump against potential overload situations and thus rounds out the concept. The exceptional high reliability, availability and suction lift capability of LEWA ecosmart as well as the very long service life of the diaphragm of at least 24 months are based on this. Moreover, the sandwich diaphragm is continuously monitored and immediately reports any fault or damage. Because of the double-layer diaphragm, you don't need to worry about a contamination of the process fluid. This allows the operation to continue for a certain time, which makes it easier to plan production downtime.

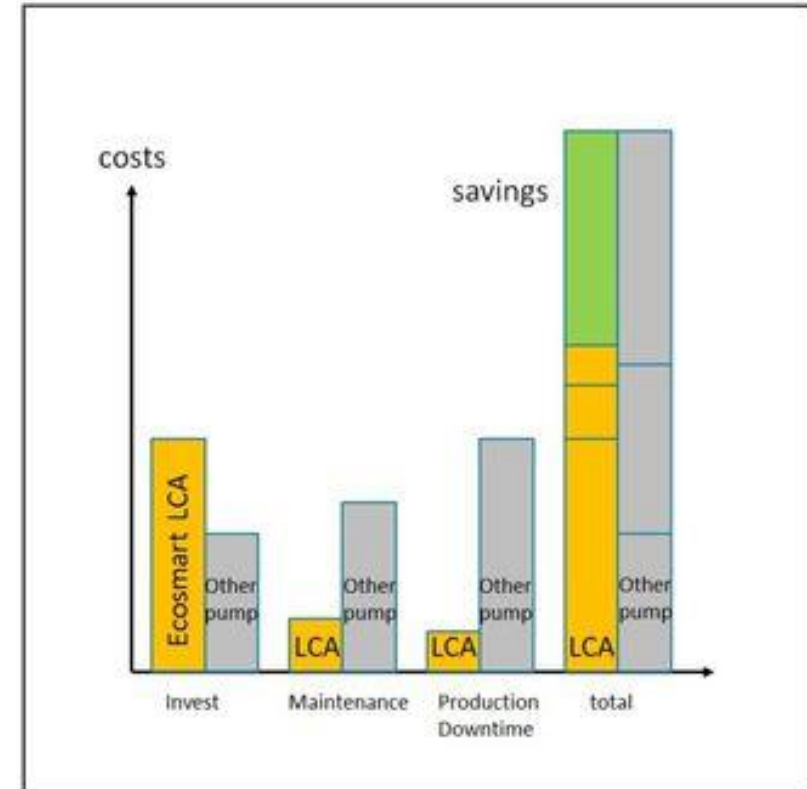

Smart Condition Monitoring from Mitsubishi Electric

The Smart Condition Monitoring (SCM) solution from Mitsubishi Electric provides an integrated approach to monitoring the condition of individual assets, and enables a holistic approach to be taken to monitoring the asset health of the whole pharmaceutical plant.

These SCM systems can be operated continuously and can be relied upon to give a simple but effective warning prior to significant failure. The 'smart' capability of the system and sensors comes from a combination of local, on-machine warnings – perhaps using the familiar traffic light system – and through having information from multiple sensors transferred over the plant network to PLCs and then on to HMIs, PCs or mobile devices for in-depth monitoring, advanced warning and more detailed analysis.

Maximizing OEE The SCM system supports a number of functions that aid in predictive maintenance, including bearing defect detection, imbalance detection, misalignment, temperature measurement, cavitation detection, phase failure recognition and resonance frequency detection. Linking multiple sensors into the control system enables the controller to analyze patterns of operation that are outside the norm, with a series of alarm conditions that provide alerts that attention is needed.

SCM can go further, by providing an essential tool to assist the pharmaceutical industry with the move from batch production to continuous production. This shift to continuous production requires increased running time between periods of scheduled maintenance, and is dependent upon the ability to reliably monitor the condition of the operation. The SCM system addresses this requirement because, along with indicating a developing problem on a machine or line, it is also able to give meaningful detail about what the problem is and how serious it might be. And by providing a complete and holistic overview of the workings of the plant's assets, it can also enable a model-based fault detection and identification system to be implemented, with an active fault diagnosis framework.



Pharma Presentations at OSIsoft 2017 User Conference

2017 - Users Conference - San Francisco - Life Sciences/Food & Beverage/Specialty Chemicals

- [Data Infrastructure and Analytics](#) This introduction talk will discuss how analytics has become a business driver encouraged by regulations. Data Analytics is commonly used and almost mandatory throughout the lifecycle of a product, from early research through development, all the way to manufacturing, and ...**Company:** OSIsoft**Industry:** Pharmaceuticals Food & Life Science
- [Monitoring Bioreactor Cell Culture Data in Real-time](#)
- Traditionally, bioreactor cell culture monitoring has occurred through physically sampling bioreactor cell cultures daily and generating discrete data on an offline analyzer. With the advance of in-situ RAMAN probes, multiple cell culture process attributes can now be measured simultaneously every ...**Company:** Regeneron Pharmaceuticals Inc.
- [Data Sharing in an OEM Environment](#)
- Utilizing both Virtual Machine (VM) technology and OSIsoft Cloud Services, Eli Lilly is implementing temporary PI System installations at original equipment manufacturer (OEM) sites for engineering studies, debug support and to establish a baseline for the machine performance before going ...**Company:** Eli Lilly and Company
- [Data Sharing in a Contract Manufacturing Environment](#) Currently, Eli Lilly does not have access to real-time data from the contract manufacturers (CM) in their Device Manufacturing group. They rely on the CM to provide reports and/or ad-hoc data. Utilizing Asset Analytics, Event Frames and OSIsoft Cloud Services, Eli ...**Company:** Eli Lilly and Company
- [Pharmaceutical Manufacturing Improvement Through Leverage of PI System Data and Analytical Tools](#) Bristol-Myers Squibb is an EA customer and has years of process data associated with: • Process development • Clinical and commercial manufacture of pharmaceuticals. This data is stored in multiple PI Systems as well as other systems. But we are challenged to find the ...**Company:** Bristol-Myers Squibb
- [The Value of the Novartis EA for the San Carlos Site and Novartis Achievements/Goals of the PI System strategy](#) Novartis is in the middle of their Enterprise Agreement (EA) partnering journey with OSIsoft. The EA experience so far has been constructive for both parties and the partnership has brought many achievements both at local sites' level and at the ...**Company:** Novartis
- [Leveraging the PI System to Build a Biologics Analytics Tool for Laboratory-Scale Bioreactor Data](#)
- A key deliverable for the Biologics Development and Biologics Manufacturing Sciences & Technology organizations at Bristol-Myers Squibb is to generate and document process knowledge that will inform the in-process control strategy for existing and/or eventual biologics manufacturing processes. Three years ago, ...**Company:** Bristol-Myers Squibb

Rockwell Eliminates Contamination Problem for Sterile Injectables Manufacturer

- Contamination on the packaging line resulted in double-digit batch losses in one year for a U.S.-based producer of sterile injectables. The problem in the process occurred during the transfer of medication from bulk vessels into individual plastic vials using a blow, fill and seal machine.
- The drug manufacturer tapped Automated Systems Inc. (ASI) to upgrade its control and visualization system. ASI created a system to automatically contain contamination on the line, issue alarms when any process metrics varied outside of preset ranges, and track and record key process data to verify the sterility of each completed batch.
- The solution relied on a manufacturing intelligence strategy based on Rockwell Automation hardware and software. Leveraging a new Allen-Bradley® ControlLogix® programmable automation controller, ASI engineers designed a system that predetermines all processing and sequencing steps, including the crucial pressurization procedure.
- The system incorporated FactoryTalk software from Rockwell Automation, including a human-machine interface (HMI) running FactoryTalk® View Site Edition (SE) software. The HMI shows the real-time state of the system in a sophisticated mimic screen. This screen – which also can be accessed via a secured web-browser for remote monitoring – gives operators a detailed overview of the status of every valve across the system, along with pressure and temperature readings.
- This enables the operator to quickly and correctly perform the right operation with optimal awareness of the entire system. FactoryTalk View SE software prompts the operator to perform certain actions and verify variables at each step in the process. In the event of a warning or alarm, the system automatically identifies the potential failure site, isolates the product there and re-sterilizes the line.
- Since implementing the new system, the manufacturer hasn't lost a single batch to contamination. Each finished batch is worth more than \$250,000, so the investment in the new system quickly paid for itself.

Saunders-VUE

Automation Portfolio



I-VUE



M-VUE



RELIABLE

State of the art continuous sensing magnetic technology

ACCURATE

State of the art continuous sensing magnetic technology

INTELLIGENT

Offers remote diagnostics to enable in critical decision making

SAVINGS

Delivers \$1.3M savings in 5 years

ZERO MAINTENANCE

Contactless operation without any maintenance

Saunders-VUE portfolio offers industry leading valve automation technology that enhances diaphragm valve intelligence delivering savings to the customer

Saunders-VUE

Automation Portfolio



Saunders I-VUE

Saunders I-VUE

Saunders I-VUE is next generation intelligent valve sensor that offers state-of-the-art continuous sensing technology with enhanced diagnostics

- Continuous electromagnetic sensing technology with 0.2mm accuracy
- Self calibration feature reducing set-up time to 3mins
- Enhanced diagnostics reducing maintenance cycles

Ideal valve automation solution for end users due to enhanced diagnostics

Saunders M-VUE

Saunders M-VUE is the most compact intelligent valve sensor that offers one step contactless valve and sensor self-calibration

- Solid State sensing technology with 0.3mm accuracy
- Self-calibration feature reducing set-up time to 3mins
- Remote and local positioning

Ideal valve automation solution for OEMs due to compact size



Saunders M-VUE

Saunders sensors deliver 90% savings every time a sensor is calibrated*

Saunders-VUE

Value Proposition

Pre-Commissioning (FAT at OEM / Skid Builder)		
Sensor is calibrated 4 times during Pre-Commissioning		
Labor Rate of \$100 / hour		
	Setup Time	Cost / Sensor
I-VUE (1 Technician)	3 minutes	\$ 5
Traditional Switch (2 Technicians)	30 minutes	\$ 50
Minimum Savings per VUE Sensor: \$45 per calibration		

Post-Commissioning (End User Location)		
Sensor is calibrated after every diaphragm change-out		
Labor Rate of \$100 / hour		
	Setup Time	Cost / Sensor
I-VUE (1 Technician)	3 minutes	\$ 5
Traditional Switch (2 Technicians)	60 minutes	\$ 100
Minimum Savings per VUE Sensor: \$95 per calibration		

Saunders Sensors deliver \$1.3M savings in 5 years for a facility with 2800 sensors

SAUNDERS-VUE SENSORS
*Save your facility \$1.3 million in five years**



Saunders-VUE Sensors

vs.



Traditional Switchbox

REQUIREMENTS PER CALIBRATION

TECHNICIANS

 One

 Two

MINUTES

 Three

 Thirty

Saunders-VUE sensors require half of the manpower and a tenth of time per calibration.

PRE-COMMISSIONING

In pre-commissioning, a sensor is calibrated **FOUR** times:

RECEIVE ACCEPTANCE TEST
PRE-COMMISSION
START-UP
PRE-CALIBRATION

COST PER CALIBRATION

 \$5.00



COST PER CALIBRATION

 \$50.00



Saunders-VUE Sensors deliver 90% savings in pre-commissioning!

POST-COMMISSIONING

In post-commissioning, a sensor is calibrated **TWO** times:

RECEIVE ACCEPTANCE TEST
DIAPHRAGM CHANGE-OUT

COST PER CALIBRATION

 \$5.00



COST PER CALIBRATION

 \$100.00



Saunders-VUE Sensors deliver 95% savings in post-commissioning!

Payback time = **FOUR** diaphragm changeouts

70

Crane ChemPharma & Energy

Saunders-VUE

I-VUE – Features

Fast Key Access Features

- Self-Calibration of the Saunders® I-VUE
- How to Force Solenoid

- Demo Mode
- Reset Password

- Adjusting Tolerance (Stroke)
- Cycle Time (Tolerance)
- Partial Counter
- Day Alarm
- Date Alarm
- Display Settings
- Output Function
- Sleep Mode
- Self Calibration Settings



- Manual calibration settings
- Disable Solenoid
- Point to Point alarm (PnP units only)
- Setting a Password
- Setting Time & Date
- Total Counter
- Restore Factory settings
- Setting Address (DeviceNet units only)
- Setting Network Speed (DeviceNet units only)

Saunders-VUE

I-VUE – Key Selling Features



Enhanced Diagnostics

- Digital Cycle Counter
- 18 features
- 15 alarms



Self Calibration

- Only 3 mins per self calibration
- Locally and remotely via control system
- No need to open enclosure



Remote Calibration

- Sensor can be calibrated remotely with integral solenoid



Reliable & Accurate

- Reliable continuous electromagnetic sensing technology
- Accuracy of 0.2 mm



Contactless

- No mechanical parts
- No wear & tear
- Operated with magnetic key



Industrial Network

- Point-to-Point
- ASi
- DeviceNet

Saunders-VUE sensors offer wide range of valve diagnostics enabling customers to use diaphragm valve like never before

Samson Valve High Control Accuracy in Pharma

- To meet the high requirements stipulated in the FDA and EHEDG regulations, Samson valve bodies are made of stainless steel. All wetted surfaces are precision-turned or polished. Additional electropolishing is used to achieve surfaces with glossy or high-gloss finishes, which reduces the surface roughness to no more than 0.25 μm . The valve bodies are free of cavities and suitable for CIP (cleaning-in-place) or SIP (sterilization-in-place).
- EPDM and PTFE diaphragms are used to shut off the valve towards the actuator and the atmosphere. End connections are available as either detachable or fixed. Exact dosing and proportioning, which are indispensable in this sector, are ensured by the high control accuracy characteristic of all Samson products.

Seeq® is the Google of Industrial Process Data

Seeq® is founded on the premise that process manufacturing companies need better solutions for deriving business insight from Industrial Process Data. The Seeq Decision Support Environment (DSE), which features an HTML-based client application and server-based platform, is the first modern application designed specifically for accelerating insight into time series data. You can think of Seeq as the “Google” of your Industrial Process Data: fast, interactive, and intuitive. Customers using Seeq experience faster insights on production data, a higher return-on-investment from existing data sources, and increased collaboration among employees to drive better operations decisions.

Seeq is an official partner of OSIsoft and recently sponsored its European and US user conferences, as well as US regional seminars. Seeq is also a sponsor of recent Emerson Exchange user conferences. Additional partnership and licensing agreements are currently underway with other industrial automation vendors and will be announced when finalized.

Seeq is a venture-backed software company with headquarters in Seattle, Washington. An accomplished executive team which brings 100 years of experience and expertise in process manufacturing, mission critical systems, and software development from OSIsoft, Microsoft, Boeing, and Honeywell. The founders and board of directors have extensive experience with successful start-up ventures in high-growth environments.

Seeq is organized as a virtual company to attract the best talent across the country and around the globe. Seeq follows agile software development techniques which rely on frequent customer touches, demonstrations, and reviews. The result is a shorter time to useful features with a faster response cycle to customer input and requests.

Seeq leverages "big data" technologies to bring industrial process data into the business decision process. This approach requires a development team that is experienced with open source innovations and technologies. Technical team members include big data architects with domain and industry experience, computer scientists experienced in grid computing and distributed systems, and data scientists specializing in advanced analytics and visualization. Thus the team is able to deliver an advanced application for better business outcomes and company improvement through industrial process data-driven decision making.

Seeq Harnessing the Power of Available Data

As with many industries, pharmaceutical and biopharmaceutical scientists and engineers at the R&D, pilot, and production scales, need a new way to harness the power of the data gathered. These industries need a new way to drive innovation through an enhanced data strategy. Crucial elements for enabling pharmaceutical process innovation include:

- Understanding the key physical situation or process
- Identifying the right process analytical technology to obtain the required data
- Connecting disparate data sources
- Implementing data analysis and visualization applications that make it easy to analyze and make changes, to improve quality and quantity of medicines

With a streamlined process development vision, including the right data management strategy and analysis applications in place, opportunities abound to dramatically improve the quality of processes and the resulting medicines, including:

- Reduced equipment cycle times and cost-saving predictive maintenance
- Development of game-changing data-driven models relating product quality to key process variables. This includes support for a proactive first principles-based process model development approach, essential for supporting regulatory filings
- Streamlined assessments of new process analytical technologies by rapidly getting insight into your process
- Automation of repeated analysis tasks and reporting for future reference
- Establishment of a truly collaborative problem solving environment

Developing better processes begins with having a broad process development vision, including a well-defined and well-understood physical situation. Without this vision, there is a slim chance that the right data will be available for analysis. In addition to understanding what data is critical, it is equally important to have the appropriate automation of sampling, electronic storage of data, and connectivity between historians and other data repositories (e.g., SQL databases).

Seeq - Choose the Right Data Management and Visualization Components

Choosing the right data management and visualization components is key. How many times have you wanted to be able to investigate an important issue, or to be proactive at designing a new process, only to stop because you don't have the data you need? Do you often decide that the pain of gathering the data, that you know exists somewhere, doesn't warrant the time and attention it takes to pull it together?

Pharma and biopharma plants often possess all the data they need to improve operations within their various data repositories, including historians, databases, etc.. However, creating insight from this information can be difficult, expensive, and time-consuming using traditional data analytics tools. Too much time and effort goes into simply getting the data into a format to be evaluated, usually resulting in frustration and a lack of thorough analysis.

With a facile data strategy, the world looks different. Imagine having the ability to easily search and interact with past and present time-series data in a "google-like" fashion and collaborate in real time. Imagine being able to make business critical decisions with more confidence, simply because you have the data in hand.

It is important to ensure that your data management applications provide:

- A strong connection with your data. Historians typically reside near the sensors and equipment. LIMS and other data stores are often spread across your business network. The right software, like Seeq®, makes it easy to connect to everything and view it all in one place.
- Automatic indexing of the sensor names or tags in the historian to make them easy to search and access the related data.
- A comprehensive connection to other data sources for the data points of interest.
- Streamlines future analysis in a way that facilitates collaboration. Work can be stored for reuse or shared with colleagues, either as a way to capture expertise, or in real-time to enable distributed discussions across an organization.

SchuF Valves with P.A.T. Technology



Dual-Probe version:

- An oversized valve spindle encases a shaft for the PAT Probe as well as a separate shaft for a traditional RTD temperature sensor
- Each instrument can be installed or removed independently of the other
- PAT probe is in direct contact with the process

Single-Shaft version :

- One shaft in the valve spindle that accommodates one PAT probe
- FT-IR probe shown here includes a 1xPT100 RTD



SchuF Valves with P.A.T. Technology

Dual-Probe Sensors

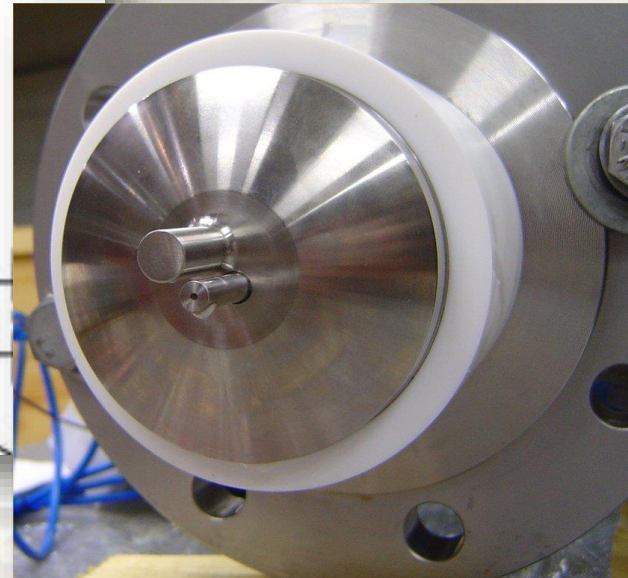
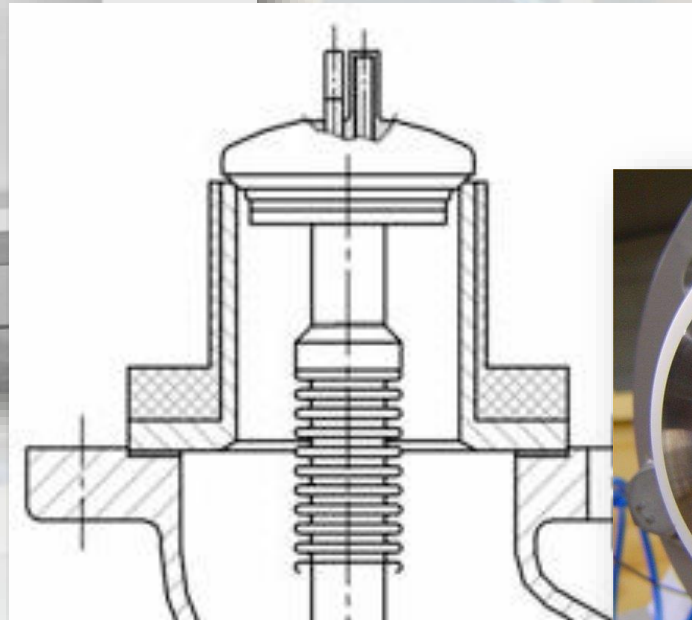
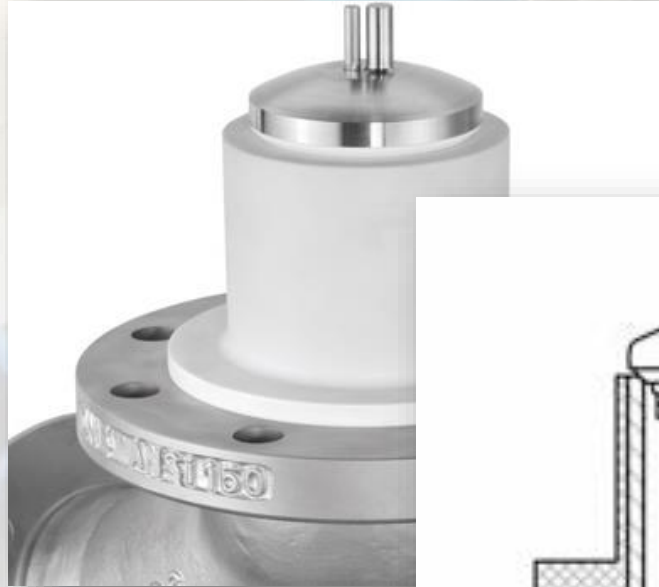

SchuF Valves with P.A.T. Technology



**LiquiSonic® Sensor
from SensoTech**

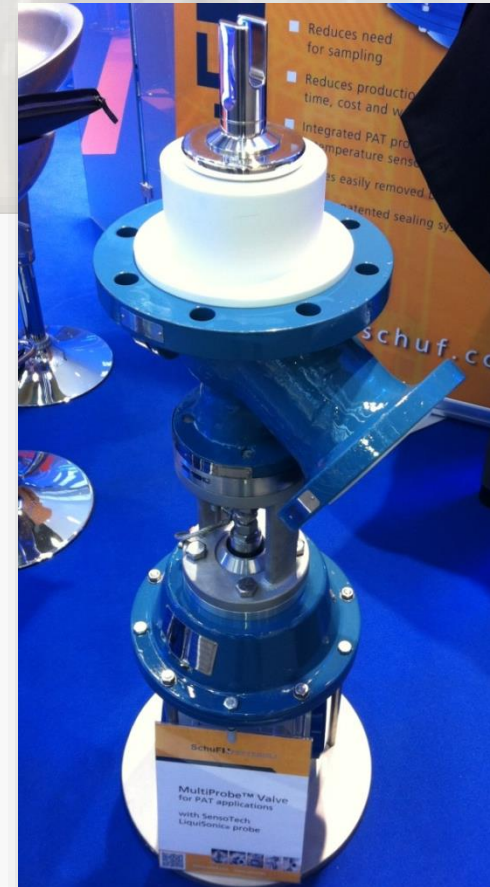
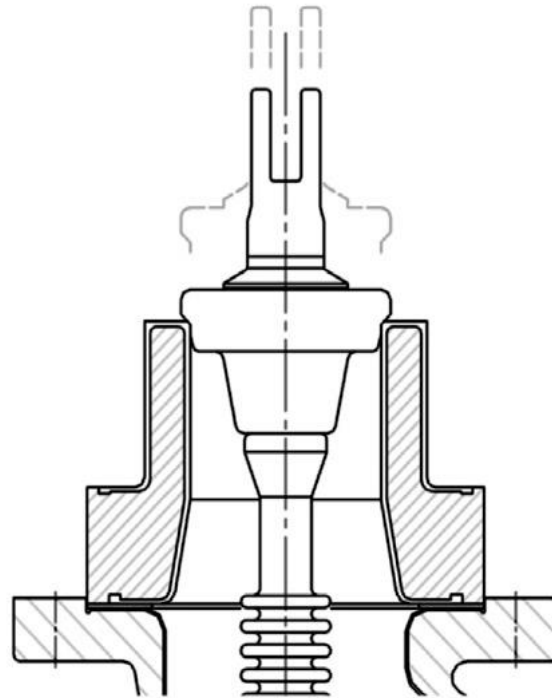

SensoTech Monitors Concentrations in Pharma Applications

SensoTech's LiquiSonic® technology is an inline analytical system for determining the concentration of liquids directly in the process, in real-time. Based on the high-accuracy measurement of sonic velocity and process temperature, SensoTech analyzers:

- Supply reliable, real-time data of solvent concentrations
- Precisely measure the content in nutrient solutions, emulsions and suspensions
- Monitor concentration of active ingredients, vitamins and proteins
- Detect phase interfaces in vessels and pipes
- Control crystallization processes

Because the measuring technology of sonic velocity is not dependent on color, turbidity or other optical attributes, the user will have no limitations, even under the most difficult application conditions.

The pharmaceutical industry specifically, sets high demands on analyzer technology configurations, such as electrical housings, electronics and sensor technology. As such, SensoTech is able to engineer a system specific to customer's needs. SensoTech sensors may be equipped with all common process adapters and fittings such as ANSI or DN flanges, Tri-clamp, Ingold or Varivent, and can be used under the most complex application conditions: by changing immersion lengths or the process adapters, SensoTech sensors fit into tanks and vessels of almost every design as well as directly in any pipe size.

SensoTech Monitors Concentrations in Pharma Applications

- A suitable entry point into the process also results from incorporation of the LiquiSonic® sensor into the bottom outlet valve (BOV) from the company SchuF, allowing measurement directly in the vessel without additional process connections. Offered under the brand MultiProbe™ the combination of sensor and valve is an ideal solution for process analytical applications in the pharmaceutical and fine chemical industry.
- The other side of the spectrum are smaller units for small-scale, multipurpose pharmaceutical manufacturing platforms (PMP)
- Every LiquiSonic® system can be easily adapted as various process conditions are modified. This concept ensures the return on investment, and decreases response times on changing boundary conditions. For new applications, an end user may create a new calculation model using process reference values together with our powerful SonicWork® software.
- Communications
- SensoTech is able to offer all current and emerging standards of signal processing. For continuous concentration, 4 ... 20mA in 2-wire loop powered or 4-wire technology, Profibus PA or Foundation Fieldbus are available. For alarm level detection and switching, a non-contact output or a relay can be configured. SensoTech analyzers can always match your installation needs.

Thermo Fisher acquires Finesse to Provide Scalable Control Automation Systems for Bioproduction

- Thermo Fisher Scientific earlier this year announced acquisition of Finesse Solutions, a development of scalable control automation systems and software for bioproduction. The business will be integrated into Thermo Fisher's Life Sciences Solutions Segment.
- Based in Santa Clara, California, Finesse Solutions is a bioprocess management technology, generating approximately \$50 million in revenue in 2016. Its proprietary Smart™ technology, which consists of sensors, controllers and software, is designed to optimize the bioproduction workflow. The company has been a technology partner of Thermo Fisher Scientific since 2013.



Thermo Finesse Smart Factory

- The SmartFactory provides an operations management solution for single-use facilities that optimizes plant-wide resource utilization, integrates manufacturing (batch) information, and facilitates training and validation record management. SmartFactory is a COTS operation management solution based on industry standard MES (manufacturing execution system) platforms.
- As the challenges in biologics and vaccine manufacturing increase with fewer blockbuster drugs, emerging markets, patent expiration, shorter time-to-market, price pressures, and increased regulatory complexity, companies are turning to multi-product single-use facilities. These facilities can provide higher yield production with fewer employees and a greatly reduced capital cost. However, they also require far greater operations management system flexibility.
- The Finesse SmartFactory has been optimized to increase productivity and maximize asset utilization, while retaining an open architecture. Bio-production process flows can be designed in a modular and scalable manner, using best-of-breed equipment (including Finesse SmartSystems), without compromising quality or compliance

Finesse Single Use Sensors for Bioreactors

- Finesse TruFluor® and TruTorr™ sensors have been specifically designed to optimize cell growth in single-use bioreactors.
- TruFluor pH
- TruFluor® pH sensors, designed for single-use applications, combine USP Class VI materials with a patented optical design to maximize stability, minimize drift, and provide superior performance.
- TruFluor DO
- TruFluor® DO sensors, designed for single-use applications, combine USP Class VI materials with a patented optical design to maximize reliability and optimize performance.
- TruTorr
- TruTorr™ sensors are designed using USP class VI materials and provide precise pressure monitoring in single-use bioreactors.
- pH+dO2 SmartPuck
- The Finesse SmartPuck single-use sensor comprises dissolved oxygen, pH, and temperature sensors in a pre-calibrated, compact assembly.



Thermo Process Mass Spectrometer

Biopharma companies can maximize product yield and increase profitability with process mass spectrometers. Process gas analyzers are engineered to meet a number of challenging process applications in the petrochemical, iron and steel, and biotechnology industries. Highly reliable and easy-to-own, Thermo Scientific™ process gas analysis technologies deliver faster, more complete, lab-quality online gas composition analysis.

The Thermo Scientific™ Prima PRO Process Mass Spectrometer is a precise, and flexible gas analyzer ideal for analyzing gases in industrial processes that can achieve the work of 10 gas chromatographs. With magnetic sector technology, the Prima PRO Process Mass Spectrometer offers precision, accuracy, and long intervals between calibrations. This is convenient in large batch manufacturing with lots of process materials, where the analyzer must be resilient to contamination to increase yield and profits.



Process Mass Spectrometry Advantages in Analyzing Drying Processes

- The Federal Drug Administration's Process Analytical Technology (PAT) initiative focused attention on the benefits of implementing process analytical techniques to improve process understanding in the pharmaceutical industries. The drying process was an obvious candidate for investigation and PAT teams began the search for suitable techniques for continuous process analysis. Initially many PAT teams considered spectroscopic techniques such as Near InfraRed (NIR) for product drying. Superficially they were attractive as they sampled directly in the bulk API; however there were several drawbacks to this approach
- Advantages of mass spectrometry technique In contrast, gas analysis mass spectrometry offers advantages of simplicity in both sampling and data manipulation.
- The MS samples from the headspace above the product, effectively measuring the bulk product in the dryer and avoiding problems caused by a lack of homogeneity in the product.
- The MS samples at the dryer outlet, either in the vacuum suction line or the outlet air line. This is simple and straightforward, requiring just a Swagelok™-type connection, heated sample line and basic particulate filter with disposable element.
- The MS operates at high vacuum, typically 10⁻⁵ to 10⁻⁶ mbar; sampling from vacuum drying processes is therefore quite practical.
- The MS can be used to check for vacuum integrity either by looking for air leaks or by helium leak checking.
- The fragmentation patterns of the molecules in the MS ion source are effectively 'fingerprints', simplifying the analysis of even complex mixtures

Veeva Vault unifies Global Data, Content and Processes across Clinical Operations in a Single Cloud Platform

- Veeva Vault CTMS is gaining momentum as customers drive toward a unified clinical operating model. Within just two months of the product's release, five customers, including a top 50 global pharmaceutical company, are implementing Veeva Vault CTMS. Veeva Vault CTMS is the industry's first application that unifies global data, content, and processes across clinical operations on a single cloud platform.
- Life sciences companies are experiencing widespread challenges with legacy CTMS applications, according to the *Veeva 2017 Unified Clinical Operations Survey*, one of the industry's largest surveys of clinical operations professionals. Nearly all sponsors say their CTMS applications are limiting their organization's ability to improve clinical operations. This is prompting companies to unify their processes and provide one source of data and information across their operations.
- "Veeva Vault CTMS establishes a new era of innovation in clinical trial management with an easy-to-use, intuitive design," said Lynn Sutton, vice president, Clinical Operations, at inSeption Group, a new Veeva Vault CTMS customer. "Veeva has a track record of helping their customers be successful. We expect to drive new levels of efficiency and productivity by streamlining our clinical processes."
- There is an industrywide drive toward a unified clinical operating model. Organizations cite the need to unify applications across their clinical operations for faster study execution and improved study quality. However, the majority of companies have challenges integrating CTMS with other clinical applications, which is limiting their ability to improve operations.
- "The ability to bring together CTMS, eTMF, and study start-up on a single, modern cloud platform is a real game-changer," said Edward Leftin, manager, Clinical Information Systems, at Ora Inc., another recent Veeva Vault CTMS customer. "Veeva will enhance our ability to leverage the same business processes and workflows throughout the lifecycle of all our studies."
- Veeva Vault CTMS is part of the Veeva Vault Clinical Suite, the industry's only cloud platform that combines EDC, eSource, CTMS, eTMF, study-startup, and site document exchange across clinical data management and clinical operations. Veeva's suite of applications empowers teams with global visibility of trial processes and information in one unified system. Now organizations can easily manage their end-to-end trial portfolio and make better, informed decisions.
- "The industry has been held back by process and system silos for decades," said Jennifer Goldsmith, senior vice president of Veeva Vault. "Customer response to the Veeva Vault Clinical Suite has been overwhelmingly positive because, for the first time, they can unify their processes to improve study execution and quality, and gain insight across the clinical lifecycle."

Yokogawa Supplies Instrumentation and Systems

Yokogawa supplies instrumentation and automation solutions to the pharma industry. McIlvaine has conducted a webinar on tunable diode laser measurement of gases where Yokogawa explained its advantages for measurement of many gases. Yokogawa also supplies complete plant information management systems.

Takeda Chemical Industries Ltd operates an active pharmaceutical ingredients (API) plant in Clondalkin, South Dublin County, Ireland. Yokogawa UK supplied an advanced batch control system for the new plant. The plant was specifically designed to be multipurpose, allowing a large number of products to be manufactured. This necessitated the use of a comprehensive batch control system, and Takeda decided to use Yokogawa's CS3000 DCS Batch Control system.

